

Hisense

Air Conditioning



Hisense Australia Product Range

2024

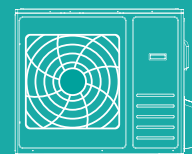

Welcome to Hisense

54 YEARS OF CORPORATE HISTORY

35 YEARS OF AIR CONDITIONING

26 YEARS OF INVERTER AIR CONDITIONING



Quality



Efficiency



Features



Performance



Trust



Comfort

Say Hi to Hisense

Intelligent Air conditioners that are built to last.

Latest technology, wide range of products and features, Hisense don't imitate, we innovate.

54 years of global appliance expertise and 35 years of air conditioning manufacturing excellence.

Pioneering 25 years of inverter technology, Hisense air conditioners are designed for energy efficiency and superior comfort.

Boasting 64 global international standards, our products are built to last and designed for Australia's harsh climate.

Whether you want to heat or cool just 1 room, multiple rooms or your whole home or workplace, Hisense has the solution.

Faster and Flexible Installations

Hisense air conditioning seamlessly integrates into your lifestyle.

With products designed for ease and flexibility of installation, saving valuable time and potential installation costs.

Our wide range of product ensures a perfect fit, whether it's your unique home design or your workplace.

Hisense – Just makes Sense.

Connectability

ConnectLife Whole-House Smart Air Solutions



Self-developed Smart Living platform



Voice control by tripartite linkage



Multi-category connectivity



Wall Mounted

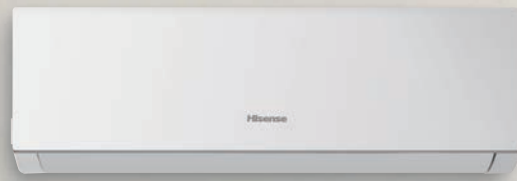

J Series



Cooling capacity	2.5Kw	3.5Kw	5.3Kw	7.1Kw	8Kw
	HAWJ9KR	HAWJ12KR	HAWJ18KR	HAWJ24KR	HAWJ28KR
Heating capacity	3.1Kw	3.8Kw	5.4Kw	7.2Kw	8Kw
	HAWJ9KR	HAWJ12KR	HAWJ18KR	HAWJ24KR	HAWJ28KR

Easy Installation

Equipped with supporting bar, it is very helpful for installer to free up one hand to complete other work during installation. Also, the under panel is detachable, benefit for drain pipe installation.



Wi-Fi Control

For controlling the climate with your smartphone via Wifi. Enter APP Menu Select Air Conditioner Set mode, temperature, airflow, etc



Quiet Mode

Equipped with indoor DC motor, unequal cross flow fan and super silent air duct design, when click quiet mode, air conditioner can run as low as 19dB, which is like the sound of fallen leaves

Refrigerant Leakage Detection

The outdoor unit will send an error code to indoor when the refrigerant leakage ratio reaches certain amount. The error code will display in indoor screen for high wall unit or display in wired controller for duct unit. The control system will stop running to ensure safe operation of the air conditioner



Evaporator Self-clean

Adopted Hisense Smart self-cleaning technology, Via a frosting and defrosting cycle, you can easily regain a clean air conditioner.

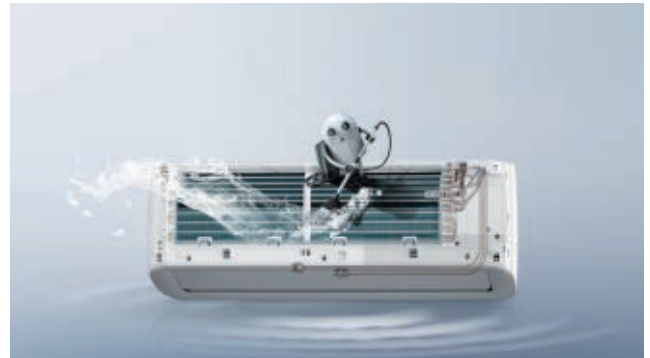

Sleep Mode

Just click the sleep mode, Hisense adopt the golden sleep temperature curve and maintain the most comfortable temperature whole night, bring user a good sleep quality

Golden Fin

To suit Australia outdoor condition which is close to seaside and damp, Hisense provide golden fin which can pass the Anti-Salt Spray test with 1000h, 2 times anti corrosion than normal blue fin design

1500 hour of Anti-Salt Spray

Anti-corrosion fin

1500h

Normal fin

500h





High End G Series



Cooling capacity	2.5Kw	3.5Kw	5Kw	7.2KW
	HAWG9KR	HAWG12KR	HAWG18KR	Coming Soon
Heating capacity	3.2Kw	3.7Kw	5.3Kw	7.5KW
	HAWG9KR	HAWG12KR	HAWG18KR	Coming Soon

HI-NANO

Release a large number double ion group, kill and remove bacteria and viruses quickly through the recycle indoor air, creating a truly healthy and good quality air environment.

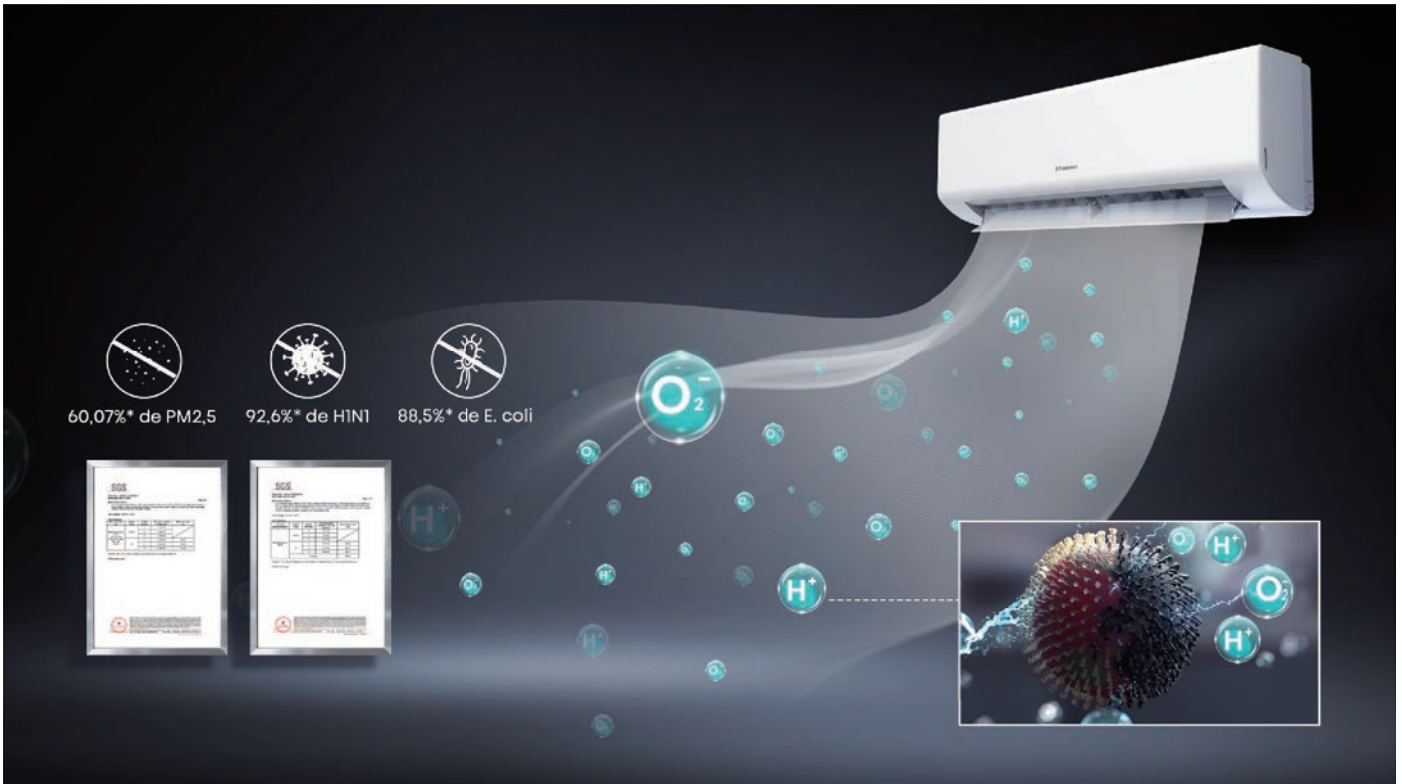

I Feel

By pressing the "I Feel" button to achieve intelligent temperature control. More accurate and comfortable.

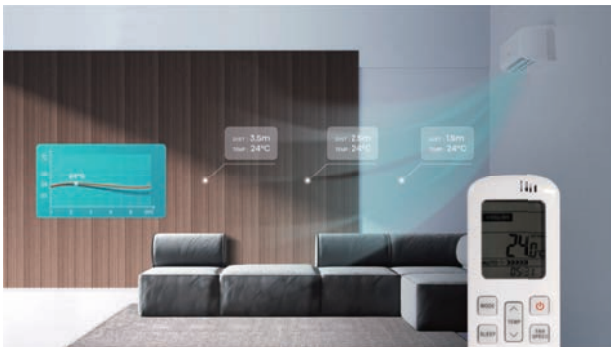

4D Auto-swing

AC's horizontal and vertical wind deflectors are controlled by independent stepping motors, which can improve distribution of cooling, make the room temperature more even.

Easy Installation

Gas and liquid Pipes can be connected when AC hang on the wall with unique easy installation structure, which is convenient and efficiency.

Smart Mode

Air conditioner is operating in smart mode by pressing one button, operate mode is adjusted by ambient temperature automatically.

Wi-Fi Control

For controlling the climate with your smartphone via Wifi. Enter APP Menu Select Air Conditioner Set mode, temperature, airflow, etc







Fast Cooling/Super Cool Model

By pressing the "SUPER" button, the air conditioner is not affected by the ambient temperature, and always runs at the maximum power and air volume to quickly reduce the indoor temperature.

Wide Voltage Operation

Built for the Australia environment, Hisense ODU takes latest inverter technology, making it can operate between 170V and 270V, no fear of voltage instability

Function Overview





		J Series				
						
Function List	No.	HAWJ9KR	HAWJ12KR	HAWJ18KR	HAWJ24KRP	HAWJ28KRP
Basic	1	Auto	●	●	●	●
	2	Cool	●	●	●	●
	3	Dry	●	●	●	●
	4	Fan	●	●	●	●
	5	Heat	●	●	●	●
Comfort	6	Anti-cold Air	●	●	●	●
	7	Auto Swing	●	●	●	●
	8	Faster Cooling	●	●	●	●
	9	Front Desk Control	●	●	●	●
	10	Louver Position Memory	●	●	●	●
	11	Sleep Mode	●	●	●	●
Efficiency	12	Full DC	●	●	●	●
	13	Timer-24h	●	●	●	●
Clean	14	Easy Cleaning Filter	●	●	●	●
	15	Washable Filter	●	●	●	●
	16	HI-NANO				
	17	No Wet Fin	●	●	●	●
	18	Self-cleaning	●	●	●	●
Convenience	19	Uniersal Indoor Unit	●	●	●	●
	20	Easy Installation	●	●	●	●
	21	Auto Restart	●	●	●	●
	22	°C/°F exchange	●	●	●	●
	23	Central Control	●	●	●	●
	24	Error Alarm Port	●	●	●	●
	25	Error Code Display	●	●	●	●
	26	I Feel	●	●	●	●
	27	On-Off Fire Alarm	●	●	●	●
	28	Temperature Compensation	●	●	●	●
	29	Voice Command	●	●	●	●
	30	Wifi Ready	●	●	●	●
	31	Wireless Remote Receive	●	●	●	●

G Series











No.	HAWG9KR	HAWG12KR	HAWG18KR
1	●	●	●
2	●	●	●
3	●	●	●
4	●	●	●
5	●	●	●
6	●	●	●
7	●	●	●
8	●	●	●
9	●	●	●
10	●	●	●
11	●	●	●
12	●	●	●
13	●	●	●
14	●	●	●
15	●	●	●
16	●	●	●
17	●	●	●
18	●	●	●
19			
20	●	●	●
21	●	●	●
22	●	●	●
23	●	●	●
24	●	●	●
25	●	●	●
26	●	●	●
27	●	●	●
28	●	●	●
29	●	●	●
30	●	●	●
31	●	●	●

Basic

-  **1. Auto**
Auto mode can be realized by remote controller or wired controller.
-  **2. Cool**
Cooling mode can be realized by the remote controller or the wired controller.
-  **3. Dry**
Dehumidifying mode can be realized by remote controller or wired controller.
-  **4. Fan**
Fan mode can be realized by remote controller or wired controller.
-  **5. Hot**
Heating mode can be realized by remote controller or wired controller.





Comfort

-  **6. Anti-Cold Air**
Prevent the cold air from blowing out during air conditioning heating. Once the heating function is turned on, enjoy the warmth immediately.
-  **7. Auto Swing**
Auto swing improve distribution of cooling, make you feel more comfortable.
-  **8. Faster Cooling**
Achieve fast cooling with high running frequency compressor, powerful fan, advanced air duct, heat-exchange system.
-  **9. Front Desk Control**
The 3D airflow panel can offer even airflow and wide airflow coverage to keep every corners of your room cool or warm.
-  **10. Louver Position Memory**
The panel louver restarts automatically at the original settings after power failure.
-  **11. Sleep Mode**
In order to give you the best sleep, my sleep function automatically adjusts the room temperature and will shut off the light of the unit.
-  **12. All DC (Full DC)**
DC compressor + DC indoor & outdoor motors + EXV.
-  **13. Timer-24h**
Set a specific time during the day to have the AC automatically turn on or off.





Efficiency

-  **12. All DC (Full DC)**
DC compressor + DC indoor & outdoor motors + EXV.
-  **13. Timer-24h**
Set a specific time during the day to have the AC automatically turn on or off.

Clean

-  **14. Easy Cleaning Filter**
The filter can be easily taken out, and easy to install.
-  **15. Washable Filter**
The filter can be cleaned for repeated use.
-  **16. HI-NANO**
Healthy high-concentration ions can effectively remove airborne dust, viruses and inhibit bacteria, including 60.07%* of PM2.5, 92.6%* of H1N1 and 88.5%* of E. coli. in 2 hours, creating a truly healthy and quality air environment.
-  **17. No Wet Fin**
After turning off the AC, the indoor fan will continue running for 30 seconds, the evaporator and other parts of the indoor unit will be blown dry, prevent mildew growth.
-  **18. Self-Cleaning**
Self-clean technology of evaporator can keep your air conditioner clean and reduce bacteria, microorganisms, oil stains and so on, via a frosting and defrosting cycle.

Lorem ipsum dolor sit amet, consectetur adipiscing elit, sed diam nonummy nibh

-  **19. Universal Unit**
The indoor unit can use to 1-1 system & Multi-system both, great helpful for the supplier to improving inventory management.
-  **20. Easy Installation**
Gas and liquid pipes can be connected when AC hang on the wall with unique easy installation structure which is convenient and efficiency
-  **21. Auto Restart**
The unit restarts automatically at the original settings after power failure.
-  **22. °C/°F Exchange**
Celsius and Fahrenheit can be converted to each other to meet different needs.



23. Central Control

Central Control can be realized with the help of central controller and communication box.



24. Error Alarm Port

When failure occurs, PCB port will output 12VDC signal for alarm (it highlights remote alarm, 12VDC can be linked to alarm lights, also alarm bells can be installed. Competitors use alarm bells)



25. Error Code Display

We can identify the Error code through the panel display. When there is an error, the error code will flash. It is easier for us to troubleshoot.



26. I Feel

The remote control is equipped with a temperature sensor to feel 1m with in the surrounding temperature.



27. On-Off Fire Alarm

With the fire control, the A/C will be turned OFF automatically when the smoke detector alarm is activated.



28. Temperature Compensation

The ambient temperature monitored by the AC can be modified by the wired controller (Manual adjustment after the initial test).



29. Voice Command

When the air conditioner is connected to Wi-Fi through the Hisense module, you can control the air conditioner by voice via Amazon or Google speakers.



30. Wifi Ready

The product is equipped with WIFI port. When WIFI function is needed, customers can purchase WIFI module.



31. Wireless Remote Receive

The wired controller can receive the control signal sent by the remote controller.

Specification

Model No.		HAWJ9KR	HAWJ12KR	HAWJ18KR	HAWJ24KR	HAWJ28KR	
Type		Heat pump	Heat pump	Heat pump	Heat pump	Heat pump	
Ratings							
Cooling Capacity	W	2500(800~3200)	3500(1200~3700)	5300(1600~6000)	7100(2200~7900)	8000(2300~8800)	
Heating Capacity	W	3100(1000~4000)	3800(1000~4500)	5400(1750~6700)	7200(2100~8000)	8000(3000~10000)	
Cooling Power	W	620(150~900)	900(240~1200)	1590(450~2200)	2150(450~3200)	2460(480~3400)	
Heating Power	W	690(180~1050)	890(210~1300)	1450(400~2200)	2100(450~3600)	2460(600~4000)	
EER	W/W	4.03	3.89	3.33	3.30	2.5	
COP	W/W	4.49	4.27	3.72	3.43	1200	
AEER	W/W	3.99	3.86	3.32	3.29	3.25	
ACOP	W/W	4.45	4.24	3.71	3.42	3.25	
Extend capacity 2/1	W	2700	3400	4600	6900	3.24	
Air Circulation	m3/h	620	620	950	1200	3.24	
TCSPF for Cooling HOT		6.430	5.685	4.680	5.649	4.730	
HSPF for Heating HOT		5.094	4.611	4.079	4.339	4.805	
TCSPF for Cooling New-Average		5.793	5.264	4.411	5.209	4.501	
HSPF for Heating New-Average		4.602	4.273	3.737	3.844	4.008	
TCSPF for Cooling Cold		6.114	5.491	4.617	5.586	4.767	
HSPF for Heating Cold		3.967	3.805	3.299	3.391	3.488	
Energy star rating for Cooling HOT		4.5	4	3	4	3	
Energy star rating for Heating HOT		3.5	3	2.5	2.5	3	
Energy star rating for Cooling New-Average		4	3.5	2.5	3.5	3	
Energy star rating for Heating New-Average		3	2.5	2	2	2.5	
Energy star rating for Cooling Cold		4.5	3.5	3	4	3	
Energy star rating for Heating Cold		2	2	1.5	1.5	1.5	
Refrigerant		R32/700g	R32/800g	R32/1150g	R32/1400g	R32/1580g	
Cooling Current	A	2.8(0.7~5.5)	4.1(1.8~7.3)	7.2(2.0~12.0)	9.6(2.0~18.3)	11.0(2.8~16.5)	
Heating Current	A	3.1(0.8~6.4)	4.1(1.6~7.9)	6.5(1.8~12.0)	9.4(2.0~20.5)	11.0(3.3~18.5)	
Indoor Unit Noise Level (sound pressure)	High(dB (A))	39	41	44	48	47	
	silent(dB (A))	25	25	32	35	32	
Indoor Unit Noise Level (sound power)	dB (A)	59	25	62	65	68	
Outdoor Unit Noise Level (sound power)	dB (A)	60	61	65	67	68	
Power Supply							
Voltage, Frequency, Phase		220-240V/50Hz-1Ph	220-240V/50Hz-1Ph	220-240V/50Hz-1Ph	220-240V/50Hz-1Ph	220-240V/50Hz-1Ph	
System							
Compressor type		Rotary	Rotary	Rotary	Rotary	Rotary	
Compressor MFG		GMCC	GMCC	GMCC	GMCC	GMCC	
Model No.		KSK89D59UEZC	KSK89D59UEZC	KTN150D53UFZ3	KTM225D43UMT	KTM225D43UMT	
Expansion Device		Capillary	Capillary	Capillary	Capillary	EEV	
Connecting Pipe Diameter							
Liquid Pipe	inch	1/4	1/4	1/4	1/4	3/8	
Gas Pipe	inch	3/8	3/8	1/2	1/2	5/8	
Features							
3DC(Indoor motor+outdoor motor+compressor)		Yes	Yes	Yes	Yes	Yes	
Vertical Auto Swing Louver		Yes	Yes	Yes	Yes	Yes	
Horizontal Auto Swing Louver		Yes	Yes	Yes	Yes	Yes	
Hidden display		Yes	Yes	Yes	Yes	Yes	
LCD Wireless Remote Controller		Yes	Yes	Yes	Yes	Yes	
Removable and washable Panel		Yes	Yes	Yes	Yes	Yes	
Washable PP Filter		Yes	Yes	Yes	Yes	Yes	
24 Hours Timer		Yes	Yes	Yes	Yes	Yes	
5 Speed and Auto Indoor Fan Control		Yes	Yes	Yes	Yes	Yes	
Dimmer		Yes	Yes	Yes	Yes	Yes	
Sleep Operation		Yes	Yes	Yes	Yes	Yes	
Smart Function		Yes	Yes	Yes	Yes	Yes	
Super Function		Yes	Yes	Yes	Yes	Yes	
Auto Restart		Yes	Yes	Yes	Yes	Yes	
Other							
Net Dimensions	WxHxD (mm)	Indoor Unit	815×270×212	815×270×212	915×315×235	1085×315×235	1213×238×315
		Outdoor Unit	780×540×260	780×540×260	810×585×280	860×650×310	900×750×340
Net Weight (Kg)		Indoor Unit	8.5	8.5	12.5	13.5	13
		Outdoor Unit	25.5	28	34	43.5	52
Packing Dimensions WxHxD (mm)		Indoor Unit	870×335×265	870×335×265	1000×390×315	1170×390×315	1289×392×318
		Outdoor Unit	910×600×360	910×600×360	940×630×385	995×720×420	1060×820×450
Gross Weight (Kg)		Indoor Unit	11	11	14.5	16	16
		Outdoor Unit	28	30	37	47.5	56
Loading Capacity (40°C) without pipe			103/216/261	103/216/261	86/174/197	63/131/150	50/104/119

Model No.		HAWG9KR	HAWG12KR	HAWG18KR
Type		Heat pump	Heat pump	Heat pump
Ratings				
Cooling Capacity	W	2500(800~3200)	3500(1200~4300)	5000(1700~6000)
Heating Capacity	W	3200(1100~4000)	3700(1200~5300)	5300(1800~7000)
Rated Input-Cooling	W	520(130~850)	810(130~1250)	1230(320~2100)
Rated Input-Heating	W	670(130~950)	830(200~1400)	1240(340~2300)
Moisture Removal	L/H.r	0.9	0.9	2.0
Air Circulation	m ³ /h	620	620	1200
EER	W/W	4.81	4.32	4.07
COP	W/W	4.78	4.46	4.27
AEER	W/W	4.76	4.29	4.01
ACOP	W/W	4.74	4.42	4.21
TCSPF(HOT)	W/W	6.630	6.059	6.135
HSPF(HOT)	W/W	5.265	5.360	5.122
TCSPF(in Average)	W/W	6.084	5.629	5.507
HSPF(in Average)	W/W	4.882	4.743	4.575
TCSPF(Cold)	W/W	6.258	5.845	5.740
HSPF(Cold)	W/W	4.414	4.240	3.957
Energy star rating for Cooling New-HOT		5	4.5	4.5
Energy star rating for Heating New-HOT		z	3.5	3.5
Energy star rating for Cooling New-Average		4.5	4	4
Energy star rating for Heating New-Average		3	3	3
Energy star rating for Cooling New-Cool		4.5	4	4
Energy star rating for Heating New-Cool		2.5	2.5	2
Refrigerant (Type / kg)		R32/0.8	R32/0.92	R32/1.2
Indoor Unit Noise Level (sound pressure)	High(dB (A))	39	39	46
	silent(dB (A))	25	25	32
Indoor Unit Noise Level (sound power)	dB (A)	59	59	64
Outdoor Unit Noise Level (sound power)	dB (A)	59	59	63
Power Supply				
Voltage, Frequency, Phase		220-240V/50Hz-1Ph	220-240V/50Hz-1Ph	220-240V/50Hz-1Ph
Rated Current	Cooling(Amp.)	2.3(0.5~5.1)	3.6(1.0~7.5)	5.5(1.4~10)
	Heating(Amp.)	3.0(0.8~5.8)	3.7(1.5~8.4)	5.6(1.5~11)
LRA	A	/	/	/
MAx	W	850/950	1250/1400	2100/2300
	A	5.1/5.8	7.5/8.4	12/13.1
System				
Compressor type		Rotary	Rotary	Rotary
Compressor MFG		GMCC	GMCC	GMCC
Model No.		KSK89D59UEZC	KSN108D34UFZ	KTN150D42UFZ
Expansion Device		EEV	EEV	EEV
Connecting Pipe Diameter				
Liquid Pipe	inch	1/4	1/4	1/4
Gas Pipe	inch	3/8	3/8	1/2
Features				
3DC(Indoor motor+outdoor motor+compressor)		Yes	Yes	Yes
Vertical Auto Swing Louver		Yes	Yes	Yes
Horizontal Auto Swing Louver		Yes	Yes	Yes
Hidden display		Yes	Yes	Yes
LCD Wireless Remote Controller		Yes	Yes	Yes
Removable and washable Panel		Yes	Yes	Yes
Washable PP Filter		Yes	Yes	Yes
24 Hours Timer		Yes	Yes	Yes
5 Speed and Auto Indoor Fan Control		Yes	Yes	Yes
Dimmer		Yes	Yes	Yes
Sleep Operation		Yes	Yes	Yes
Smart Function		Yes	Yes	Yes
Super Function		Yes	Yes	Yes
Auto Restart		Yes	Yes	Yes
Other				
Length/Height	m	20/10	25/10	30/20
Net Dimensions WxHxD (mm)	Indoor Unit	745×270×206	745×270×206	1086×315×229
	Outdoor Unit	780×540×260	810×585×280	860×667×310
Net Weight (Kg)	Indoor Unit	8.5	8.5	13.5
	Outdoor Unit	30	33	51
Packing Dimensions WxHxD (mm)	Indoor Unit	800×335×260	800×335×260	1170×390×315
	Outdoor Unit	910×600×360	940×630×385	995×720×420
Gross Weight (Kg)	Indoor Unit	11	11	16
	Outdoor Unit	33	36	54
Loading Capacity (40°C) without pipe		103/216/261	96/197/228	63/131/150



High Static Ducted System



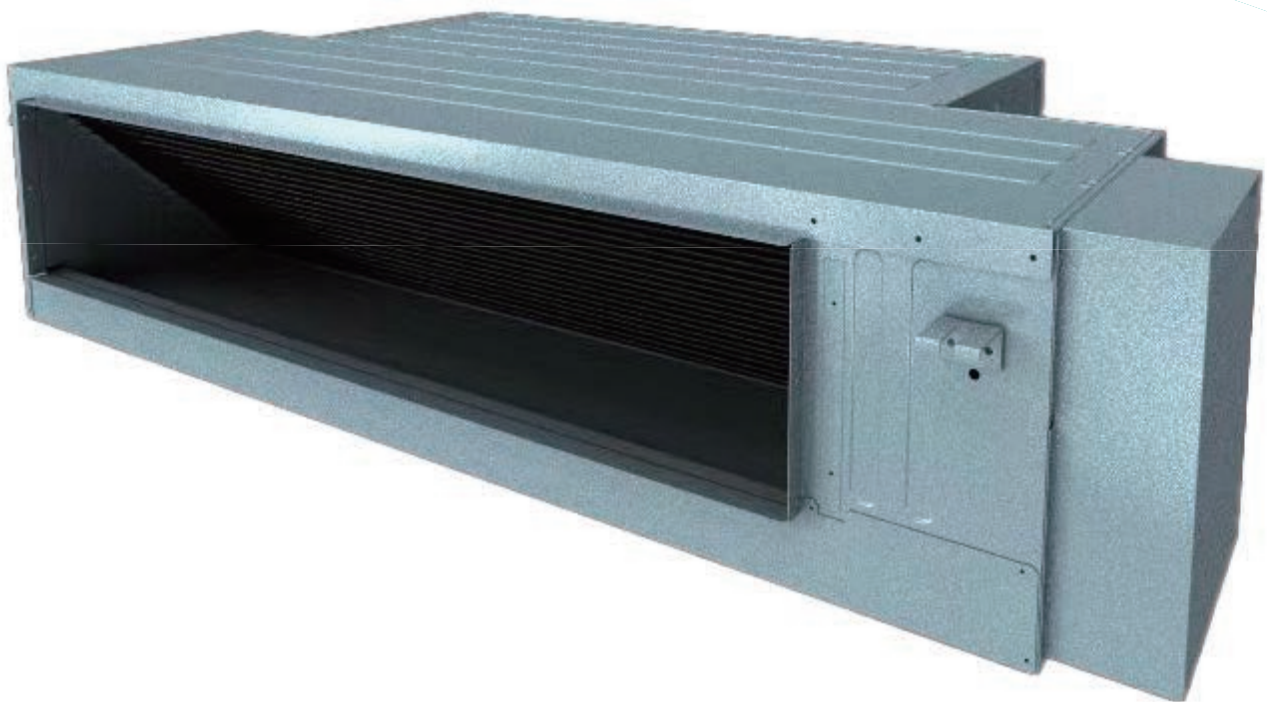

Easy Installation | High Comfort | Easy to Use

Hisense



Product Range



TYPE	8.5kW	10kW
<p>High static duct</p>	 <p>AUD-85UX4RSH1</p>	 <p>AUD-100UX4RSH1</p>
<p>Outdoor unit (single phase)</p>	 <p>AUW-85U4RK1</p>	 <p>AUW-100U4RK1</p>



12.5kW

14kW

16kW



AUD-125UX4RSH1



AUD-140UX4RSH1



AUD-160UX4RSH1



AUW-125U4RH1



AUW-140U4RH1



AUW-160U4RH1

Bring You Comfort All Year Round

Super Big Airflow With Long Ductwork

Due to high efficiency powerful DC fan motor, enlarge super big airflow up to 1000 l/s from above 12.5kw, meaning you can stay comfortable everywhere in your home.

Although airflow will decrease with the long designed ductwork, Hisense duct can reach 100% airflow in 180Pa, 880l/s in 250pa, to bring ultimate comfort.

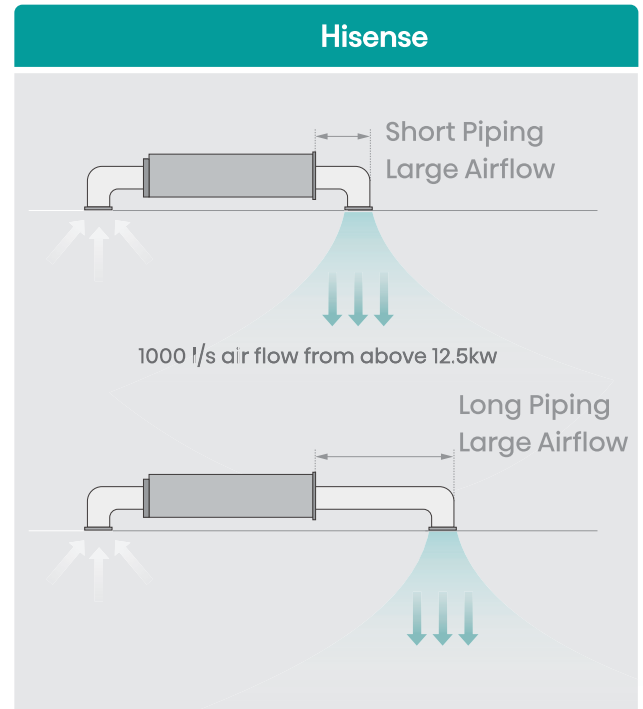
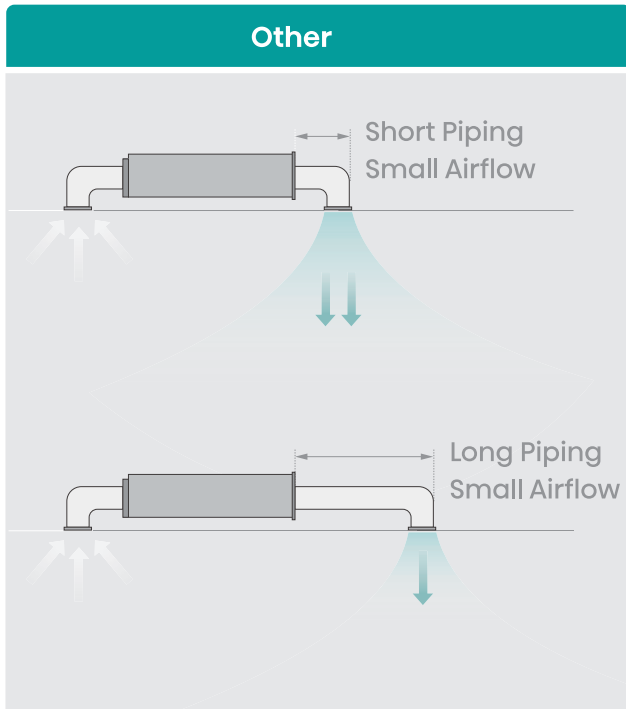

Zone Control

Zone control technology is one ideal solution for individual room air conditioning, it works when some rooms do not need the air conditioning. By using controller, it can control up to 8 zones.

Control up to 8 zones



HI-NANO Air Purification(optional part)

General filters in air purifiers are effective against airborne bacteria and viruses, however Hisense HI-NANO technology also works to prevent long-lasting bacteria and viruses. Using the Connect Life APP provides access to your air conditioner anywhere, anytime. Turn HI-NANO on even while you're not home and still enjoy 24-hour quality.

note: HI-NANO part model Hinano-01A(E) is required to installed in duct unit



Bacteria lose their activity after being absorbed by ions

Bacteria eliminate and generate water

High Energy Efficiency

Hisense indoor units are equipped with a high efficiency DC fan motor. Hisense's DC motor can deliver a high motor efficiency by utilising high power permanent magnets. This is more efficient than convectional AC motors that use induced magnetism.

DC motor efficiency (comparison with a conventional AC motor)

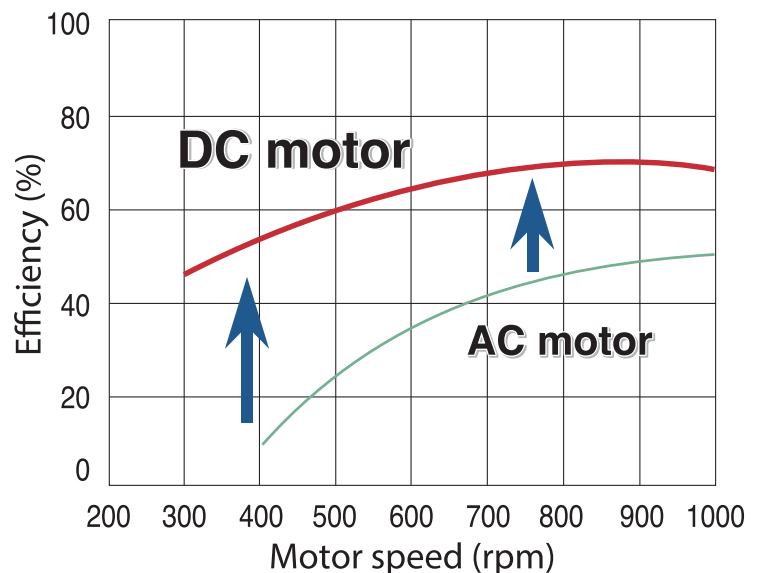

Perfect To Fit Every Place



Compact Design

With today's modern home designs having higher ceilings with smaller roof spaces, Hisense High Static Duct has a low-profile height of 360mm, to allow it to fit comfortably into the constricted roof spaces.

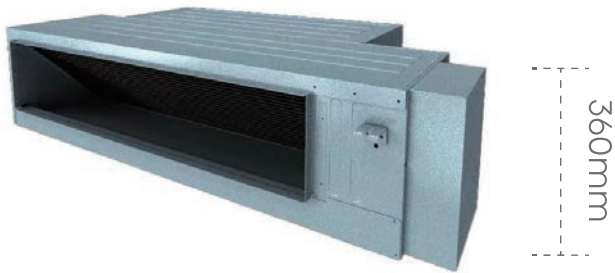

Height is only 360mm

External Static Pressure Accurate Adjustment

Not only it is possible to adjust the external static pressure setting via wired controller, convenient to adjust static pressure, but also achieve precision control of 1 Pa, give the most accurate external static pressure setting in class and deliver the optimum airflow to your home always.

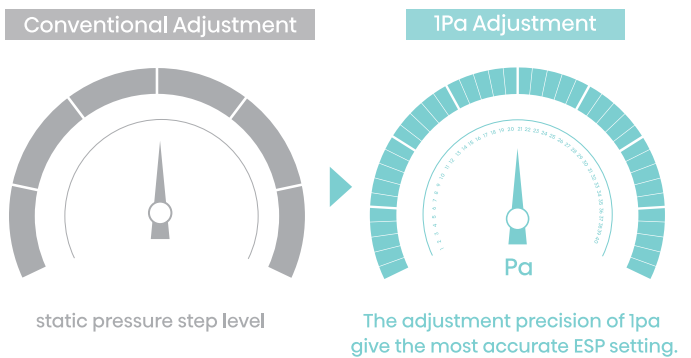

Easy installation

A splittable type indoor unit can separate into more parts, making it easier to position into tight roof space, also perfect for renovation. Also with compact design means duct can be manoeuvred into tight installation spaces. Installation has never been this easy.

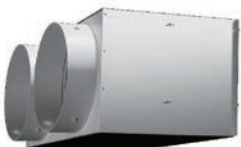

Fan Cover





Heat Exchanger



Reliable Outdoor Unit Performance

Constant Comfort Air Conditioning

One advantage of Hisense inverter technology includes its ability to ensure precise temperature control and offer a wider power output range to perform in even the most extreme conditions in Australia ensuring constant comfort

Cooling/Heating	LOW ROOM TEMP	MID ROOM TEMP	HIGH ROOM TEMP
			
Cooling	← 6KW		→ 17KW
Heating	← 18.5KW		→ 6KW

Graph shows each models' 12.5 kW High Static Ducted systems performance range during cooling and heating.

Heating focus design

To suit Australia cold zone condition, Hisense 12.5/14/16kw unit takes heating focus system design, the outdoor unit heat exchanger pipe diameter is $\Phi 8$, different from competitors $\Phi 7$ design. When system is working in heating, it will bring 14% increase in heat exchanging area, reduce the pressure loss, the heating capacity and COP get highly increased, give the end user powerful heating.

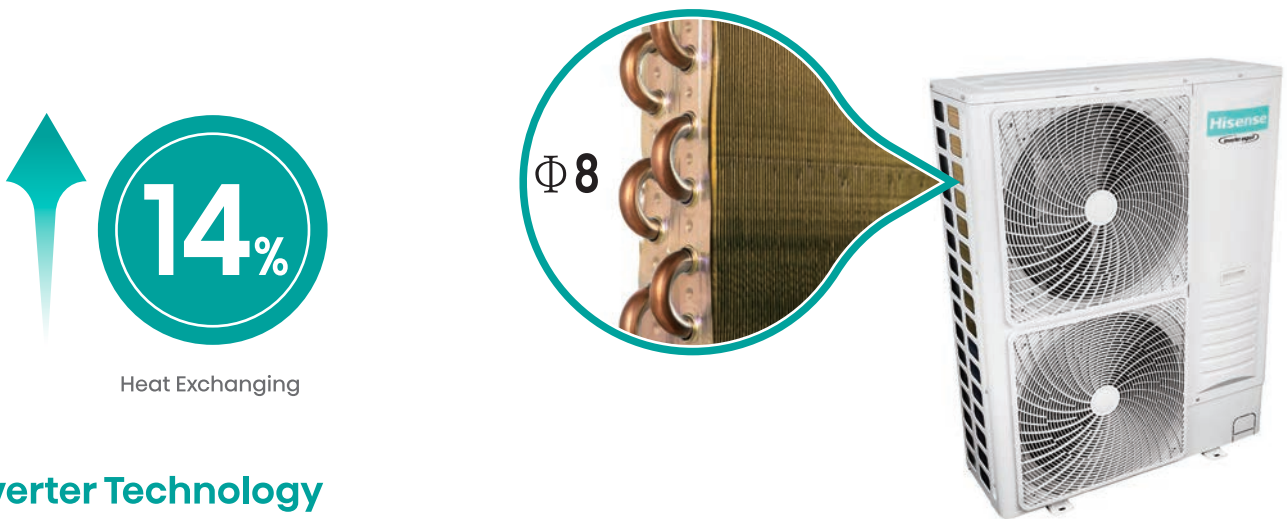

Inverter Technology

Adopting the advanced DC Fan Motor on the outdoor unit and inverter technology, allows the compressor to automatically adjust its speed in response to changes in room temperature and user settings. This is different to conventional fixed-speed compressors, which frequently shut off and switch on during operation. This technology ensures optimum comfort by maintaining the desired temperature with little fluctuation, while optimising power usage, reducing energy consumption and reducing operating costs.

Wide Operating Range

Built for the harsh Australian climate, Hisense duct system takes latest inverter technology, making it can operate in cooling mode in temperature up to 50 C

Note: 12 5kw/14kw/16kw reaches 50 C

Golden Fin

To suit Australia outdoor condition which is close to seaside and damp, Hisense provide golden fin which can pass the Anti-Salt Spray test with 1000h, 2 times anti corrosion than normal blue fin design.

RJ45 plug for DRED PCB

As Australia requires a DRED connection, to counter this need Hisense can provide a RJ45 port that can establish a connection within 5 seconds. This will result in shortened installation times for the dealer or installer.

Zone Wired Controller



FEATURES

1. Clear, backlit display with easy-to-read text.
2. Home leave function can turn your air conditioner on automatically when room temperature drops below 8°C.
3. Quick cool/heat mode, which temporarily increases air conditioning power to more rapidly reach your desired operating temperature, before automatically returning to normal operation.
4. Set Temperature Mode Changeover, automatically switches from a cooling to heating cycle, or a heating to cooling cycle at pre-set points.
5. Temperature Limit, to predefine a temperature range for cooling or heating cycles, helping you reduce your energy consumption.
6. The Zone Wire Controller is equipped with an inbuilt Wi-Fi module, which can be conveniently utilized by a smart phone device.
7. Color resistive touch screen interface with three buttons, easy to operation.

Zone wired controller Model no.	HACZ01
Dimension(WxH)	120mm x 120mm
Screen Size	4.3 inch
Applicable unit type	Duct
Power supply	DC 12V
zone quantity	8 zone

Zone control interface Model no.	HAAZ01
zone quantity	8 zone
Damper power supply	AC 24V

Touch Screen Wire Controller

Inbuilt WI-FI module

The Wired Controller is equipped with a inbuilt WI-FI module, which can be conveniently utilised by a smart phone device.



Zone Status Control

Zone Control

Zone control technology is one ideal solution for individual room air conditioning , it works when some rooms do not need the air conditioning. By using controller, it can control up to 8 zones.

Group Control

Zones can be separated into multi groups, just open the group button, you can easily open all zones in this group.

Precise Comfort

Airflow Volume Control

Damper can be accurately controlled with a interval of 5%, give you the most precise comfort.

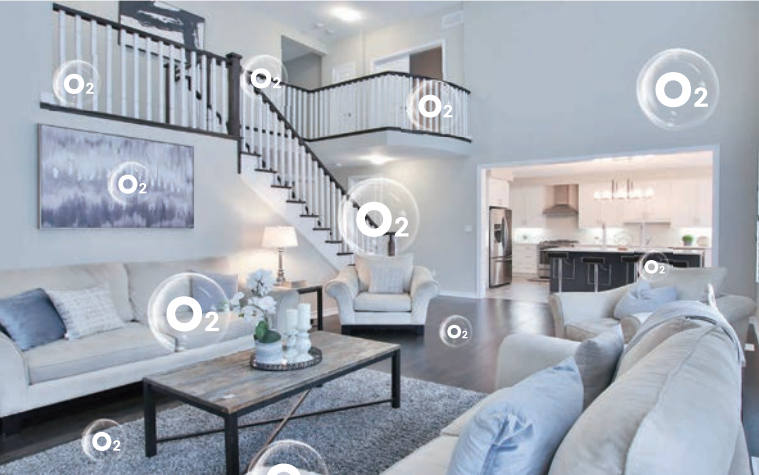

Healthy Comfort

HI-NANO

Just open HI-NANO mode by controller, you now have control of clean, clean air whenever you need it.



Connect Life APP, One-touch Control, Anytime, Anywhere

Individual comfort

Airflow volume control

The damper opening can be controlled with the Connect Life App. Adjust the air volume conveniently according to your lifestyle.



Open the living room damper when the family gathers.

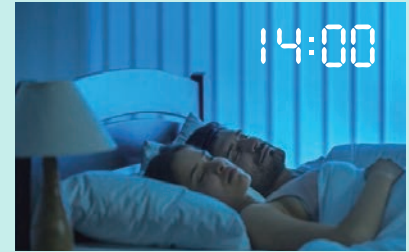
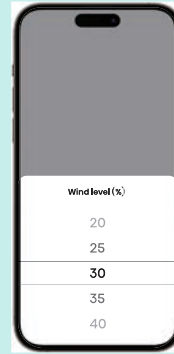
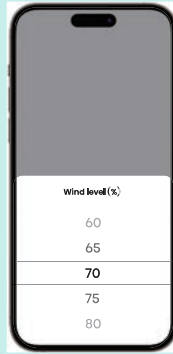

For daily naps, reduce airflow volume so that it doesn't get too cold.

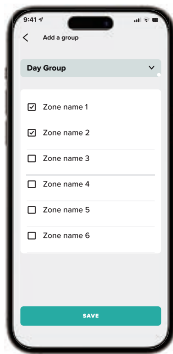

Zone Status Control

Zone Control

Zone control technology is one ideal solution for individual room air conditioning, it works when some rooms do not need the air conditioning. By using controller, it can control up to 8 zones.

Group Control

Zones can be separated into multi groups, just open the group button, you can easily open all zones in this group.

Auto Comfort

Timer

You can set unlimited quantity timer/day, according to your lifestyle, you can set the target mode/temperature/fan speed/open zones, set desired start date and end date for this setting, one time setting, all year automatic operation, realize day&night for your life style with timers.



Pre cool 30 minutes in the morning in living room

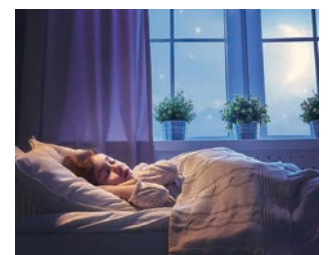

Pre cool 30 minutes before going to bed

Healthy Comfort

HI-NANO

Just open HI-NANO mode by app with fan mode, clean air whenever you need it even when you are outside.

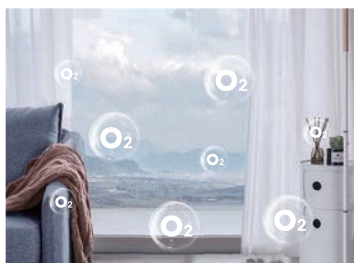

Energy Management

Power Consumption Statics

Power consumption, help to manage the air conditioner operation and save money

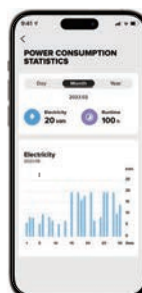

Controllable Function List





Type	Wired Controller	Zone Wired Controller	zone APP from zone wired controller	normal APP	Wireless controller+ singal receiver
model	HACW02	HACZ01	/	HAAW01	R2-01+R-A01Z(E)
Start/stop operation	•	•	•	•	•
Modes:On/Off/Cooling/Heating/Dry/Fan/Auto	•	•	•	•	•
Temperature Setting	•	•	•	•	•
Fan speed setting	•	•	•	•	•
Sleep mode	•	•	•	•	•
High nano healthy function ON/OFF	•	•	•	•	•
home leave mode		•	•	•	
24 hours Timer	•	•	•	•	•
Weekly timer	•		•	•	
Yearly timer			•	•	
Error Notification	•	•	•	•	
Wireless Remote Receive	•	•			
Child Lock	•	•			•
Operation Monitor	•	•	•	•	
Filter Cleaning Remind	•	•			
Filter Cleaning Timing	•	•			
Room Temperature Display	•	•	•	•	
Clock	•	•	•	•	•
Mode Lock	•	•			
Temperature Range Limit	•	•			
Temperature reset		•			
Auto Shutdown		•			
Zone ON OFF		•	•		
Damper Step Settings		•	•		
Enter zone name		•	•		
inbuilt wifi		•			
Operation from outside			•	•	
Multiple Users			•	•	
energy consumption monitor			•	•	
connected indoor unit type	duct/cassette	duct	duct	duct/cassette	duct/cassette

Note: energy consumption monitor & zone control functions are for duct unit only in APP







FUNCTION OVERVIEW

Function List		High Static Duct				
						
No. Model		AUD-85UX4RFHI	AUD-100UX4RFHI	AUD-125UX4RFHI	AUD-140UX4RFHI	AUD-160UX4RFHI
Basic	1 Auto	●	●	●	●	●
	2 Cool	●	●	●	●	●
	3 Dry	●	●	●	●	●
	4 Fan	●	●	●	●	●
	5 Heat	●	●	●	●	●
Comfort	6 Anti-cold Air	●	●	●	●	●
	7 Auto Swing					
	8 Faster Cooling	●	●	●	●	●
	9 Louver Position Memory					
	10 Multi Zoning	●	●	●	●	●
	11 Round Flow					
Efficiency	12 Sleep Mode	●	●	●	●	●
	13 Full DC	●	●	●	●	●
	14 Motor Hi-smart	●	●	●	●	●
Flexible	15 Timer-24h	●	●	●	●	●
	16 Duct Static Pressure Setting	●	●	●	●	●
	17 Easy Cardboard					
	18 Easy Cleaning Filter					
	19 High Ceiling Application(3m/4m)					
Healthy	20 Washable Filter					
	21 Fresh Air Intake					
	22 Healthy Drain Pan					
	23 No Wet Fin	●	●	●	●	●
Smart	24 Self-cleaning	●	●	●	●	●
	25 8℃ Special Heating	●	●	●	●	●
	26 Auto Restart	●	●	●	●	●
	27 BACnet Gateway	●	●	●	●	●
	28 ℃/℉ Exchange					
	29 Central Control	●	●	●	●	●
	30 Child Lock	●	●	●	●	●
	31 Display Switching	●	●	●	●	●
	32 Energy Consumption Monitor	●	●	●	●	●
	33 Error Alarm Port	●	●	●	●	●
	34 Error Code Display	●	●	●	●	●
	35 Filter Cleaning Remind	●	●	●	●	●
	36 I Feel	●	●	●	●	●
	37 Individual Airflow Control					
	38 On-Off Fire Alarm	●	●	●	●	●
	39 Setpoint Range Set	●	●	●	●	●
	40 Temperature Compensation	●	●	●	●	●
41 Weekly Schedule Timer	●(app)	●(app)	●(app)	●(app)	●(app)	
42 Wifi Ready	●	●	●	●	●	
43 Wireless Remote Receive	●	●	●	●	●	
Stability	44 Inner Pump					
	45 Modbus Gateway	●	●	●	●	●
	46 Water Level Switch					

Basic

-  **1. Auto**
Auto mode can be realized by remote controller or wired controller.
-  **2. Cool**
Cooling mode can be realized by the remote controller or the wired controller.
-  **3. Dry**
Dehumidifying mode can be realized by remote controller or wired controller.
-  **4. Fan**
Fan mode can be realized by remote controller or wired controller.
-  **5. Hot**
Heating mode can be realized by remote controller or wired controller.





Comfort

-  **6. Anti-Cold Air**
Prevent the cold air from blowing out during air conditioning heating. Once the heating function is turned on, enjoy the warmth immediately.
-  **7. Auto Swing**
Auto swing improve distribution of cooling, make you feel more comfortable.
-  **8. Faster Cooling**
Achieve fast cooling with high running frequency compressor, powerful fan, advanced air duct, heat-exchange system.
-  **9. Louver Position Memory**
The panel louver restarts automatically at the original settings after power failure.
-  **10. Multi Zoning**
Allows up to XX individual climate zones with one indoor unit.
-  **11. Round Flow**
"Round air supply optimizes room airflow, ensure the comfortable airflow goes to every corner and the temperature perfectly balance the integral space."
-  **12. Sleep Mode**
Press the SLEEP button, and the operation mode changes from adult SLEEP, elderly SLEEP, youth SLEEP and children SLEEP to closed SLEEP mode. Adjust the temperature curve according to different SLEEP modes. The temperature curve is customized within 8 hours according to the needs of different groups of people.





Efficiency

-  **13. All DC (Full DC)**
DC compressor + DC indoor & outdoor motors + EXV.
-  **14. Moter Hi-Smart**
Advanced inverter technology makes Hisense the inverter expert.
-  **15. Timer-24h**
Set a specific time during the day to have the AC automatically turn on or off.

Flexible

-  **16. Duct Static Pressure Setting**
It is possible to adjust the ESP setting via wired controller. And the precision of 1 Pa can give the most accurate ESP setting in class.
-  **17. Easy Cardboard**
Guide Cardboard makes it easy to install hook of the indoor unit.
-  **18. Easy Cleaning Filter**
The filter can be easily taken out, and easy to install.
-  **19. High Ceiling Application (3m/4m)**
The wired controller can be used to adjust the airflow according to the installation height and ensure that cool air blows down to people's activity area.
-  **20. Washable Filter**
The filter can be cleaned for repeated use.

Healthy

-  **21. Fresh Air Intake**
"Fresh air intake interface is reserved on the side panel, which can be connected to air duct to introduce fresh air into the room with fresh air intake function, the indoor air is fresh and healthy."
-  **22. Healthy Drain Pan**
Antibacterial Module can effectively purify condensed water and provide more healthy air supply.
-  **23. No Wet Fin**
After turning off the AC, the indoor fan will continue running for 30 seconds, the evaporator and other parts of the indoor unit will be blown dry, prevent mildew growth.
-  **24. Self-Cleaning**
Self-clean technology of evaporator can keep your air conditioner clean and reduce bacteria, microorganisms, oil stains and so on, via a frosting and defrosting cycle.

Smart



25. 8°C Special Heating

During absence, the indoor temperature can be maintained at a certain level.



26. Auto Restart

The unit restarts automatically at the original settings after power failure.



27. BACnet Gateway

The indoor unit can be connected to BMS system of the BAC net protocol by coordinating with B544E communication box.



28. °C/°F Exchange

Celsius and Fahrenheit can be converted to each other to meet different needs.



29. Central Control

Central Control can be realized with the help of central controller and communication box.



30. Child Lock

By setting the key lock, effectively avoid misoperation setting.



31. Display Switching

The wired controller can be set to display ambient temperature and set temperature.



32. Energy Consumption Monitor

Power consumption can display on the CONNECT LIFE APP. (The user can check the power consumption on the APP)



33. Error Alarm Port

When failure occurs, PCB port will output 12VDC signal for alarm (it highlights remote alarm, 12VDC can be linked to alarm lights, also alarm bells can be installed. Competitors use alarm bells)



34. Error Code Display

We can identify the Error code through the panel display. When there is an error, the error code will flash. It is easier for us to troubleshoot.



35. Filter Cleaning Remind

If the AC runs for a long time, it will remind the user of cleaning the filter.



36. I Feel

The remote control is equipped with a temperature sensor to feel 1m with in the surrounding temperature.



37. Individual Airflow Control

Each deflector can be controlled separately by a wired controller.



38. On-Off Fire Alarm

With the fire control, the A/C will be turned OFF automatically when the smoke detector alarm is activated.



39. Setpoint Range Set

The setting of temperature range can be modified by the wired controller (manual modification can be realized).



40. Temperature Compensation

The ambient temperature monitored by the AC can be modified by the wired controller (Manual adjustment after the initial test).



41. Weekly Schedule Timer

Timer can be set to start operation anytime on a daily or weekly basis.



42. Wifi Ready

The product is equipped with WIFI port. When WIFI function is needed, customers can purchase WIFI module.



43. Wireless Remote Receive

The wired controller can receive the control signal sent by the remote controller.

Stability



44. Inner Pump Standard

Inner water pump to drain the condensate water.



45. Modbus Gateway





The indoor unit can be connected to BMS system of the Modbus protocol by coordinating with B544E communication box.



46. Water Level Switch

The float switch can ensure the water always under the safety level, even if the pump failed or the drain is blocked.

FUNCTION OVERVIEW

							
Function List	No.	Model	AUW-85U4RK1	AUW-100U4RK1	AUW-125U4RHI	AUW-140U4RHI	AUW-160U4RHI
Efficiency	1	Motor Hi-Smart	●	●	●	●	●
	2	Twin Rotary compressor	●	●	●	●	●
Flexible	3	Charging Valve	●	●	●	●	●
	4	Hi-Checker			●	●	●
	5	Night Noise Control	●	●	●	●	●
	6	Refrigerant Pre charged	●	●	●	●	●
	7	Service Window-7 Segment Display			●	●	●
	8	Stop Valve Inside			●	●	●
Smart	9	Intelligent Defrost	●	●	●	●	●
	10	Service Window-Cooling only			●	●	●
	11	Service Window-Energy Management			●	●	●
	12	Service Window-Forced Defrost			●	●	●
	13	Service Window-Pump Down			●	●	●
Stability	14	3-minute Protection	●	●	●	●	●
	15	Compressor Heating Belt			●	●	●
	16	High Pressure Protection	●	●	●	●	●
	17	Leakage Detection	●	●	●	●	●
	18	Long Pipe	●	●	●	●	●
	19	Low Pressure Protection	●	●	●	●	●
	20	Low Voltage (176V)	●	●	●	●	●
	21	PCB with Insect Prevention	●	●	●	●	●
	22	Refrigerant cooled PCB					

Efficiency



- 1. Motor Hi-Smart**
Advanced inverter technology makes Hisense the inverter expert. Better energy efficiency with external motor drive technology.



- 2. Twin Rotary Compressor**
Twin rotary compressor has less noise and vibration.

Flexible



- 3. Charging Valve**
The charging valve makes after-sales service easier.



- 4. Hi-Checker**
The AC can connect to Hi-Checker to monitor the product parameters, including discharge temperature, indoor coil temperature, outdoor coil temperature, etc.



- 5. Night Noise Control**
By setting DIP, can reduce the noise of the ODU operation, to ensure the outdoor silence when sleep at night.



- 6. Refrigerant Precharged**
Up to 80% LCAC project can be installed without additional refrigerant charge.



- 7. Service Window-7 Segment Display**
The fault code and AC running parameters will show on the 7-segment display.



- 8. Stop Valve Inside**
The new built-in design, it can be realize 4 way pipe connection.

Smart



- 9. Intelligent Defrost**
The optimized defrosting logics ensures better heating capacity and cleaner defrosting.



- 10. Service Window-Cooling Only**
By setting DIP, lock the unit, so it can not run in heating mode.



- 11. Service Window-Energy Management**
By setting DIP, limit the maximum power input and decrease the outdoor noise.



- 12. Service Window-Forced Defrost**
By setting DIP, the AC will run in defrosting mode.

Smart



- 13. Service Window-Pump Down**
Recovering the refrigerant to the outdoor unit.

Stability



- 14. 3-minute Protection**
When the AC stops running by accident, the compressor will restart after 3 minutes to balance the system.



- 15. Compressor Heating Belt**
AC with compressor electric belt can still run stably in frigid regions.



- 16. High Pressure Protection**
The outdoor unit is equipped with a high-voltage switch to ensure the product reliability.



- 17. Leakage Detection**
The AC can detect and alert the refrigerant leakage if it occurs by monitoring the parameter abnormality.



- 18. Long Pipe**
the ACs With high installation flexibility.



- 19. Low Pressure Protection**
The outdoor unit is equipped with a low-voltage switch to ensure the product reliability.



- 20. Low Voltage(176V)**
The AC can still run stably even when the voltage is low to 176V.









- 21. PCB with Insect Prevention**
The structure of PCB prevents insects from entering.



- 22. Refrigerant cooled PCB**
Hisense uses refrigerant cooling technology to cool the electrical control box. It overcomes the poor heat dissipation and high ambient temperature issues to maintain efficient operation even at harsh environment.

Specification

indoor unit model		AUD-85UX4RSH1	AUD-100UX4RSH1	AUD-125UX4RSH1
outdoor unit model		AUW-85U4RK1	AUW-100U4RK1	AUW-125U4RK1
Indoor picture				
Outdoor picture				
rated capacity	cooling(kw)	8.5	10.0	13.0
	heating(kw)	10.0	11.0	15.5
capacity range	cooling(kw)	4.2~11	4.2~11.5	6.0~17.0
	heating(kw)	4.2~11.2	4.2~11.6	6.0~18.5
power input	cooling(kw)	2.54	3.03	3.61
	heating(kw)	2.60	2.90	3.78
EER/AEER	cooling(kw/kw)	3.35/3.33	3.30/3.28	3.60/3.566
COP/ACOP	heating(kw/kw)	3.846/3.82	3.79/3.78	4.10/4.064
TCSPF(residential)	cold/average/hot	4.48/4.39/4.68	4.54/4.34/4.61	4.75/4.58/4.93
HSPF(residential)	cold/average/hot	3.23/3.74/4.19	2.71/3.09/3.64	3.72/4.15/4.49
airflow (H/M/L)	l/s	800/640/555	800/640/555	1020/810/710
External static pressure	pa	250	250	250
indoor sound Level(H/M/L)	sound pressure dB(A)@1.5m	50/47/44	50/47/44	56/53/49
Indoor dimension(h*w*d) (with PCB)	mm	360*1520*820	360*1520*820	360*1520*820
Indoor packing dimension(h*w*d)	mm	440×1650×1055	440×1650×1055	440×1650×1055
supply air opening flange(H*W)	mm	245*1152	245*1152	245*1152
return air opening	mm	2*400(Oval)	2*400(Oval)	2*400(Oval)
indoor net weight	kgs	60.0	60.0	66.0
Outdoor dimension(h*w*d)	mm	750*900*340	750*900*340	1460*975*330
Outdoor packing dimension(h*w*d)	mm	820×1060×450	820×1060×450	1590×1040×435
outdoor net weight	kgs	57.5	57.5	98.0
power supply	V/Hz	1 phase,220-240V,50Hz	1 phase,220-240V,50Hz	1 phase,220-240V,50Hz
current	Cooling(A)	11.4	13.6	16.2
	Heating(A)	11.5	13.0	16.9
Maximum current(Rated current)	A	19.0	19.0	16.9
liquid pipe diameter	mm	9.5(3/8) (flared)	9.5(3/8) (flared)	31.0
gas pipe diameter	mm	15.9(5/8) (flared)	15.9(5/8) (flared)	9.5(3/8) (flared)
drain	mm	ID 25/OD 32	ID 25/OD 32	15.9(5/8) (flared)
Max pipe length	m	50	50	ID 25/OD 32
Max height drop	m	30	30	75*
Pre charge length	m	20	20	30
Cooling temperature	°C	-10~46	-10~46	-10~50
Heating temperature	°C	-15~24	-15~24	-15~24
outdoor sound level(H)	sound power dB(A)	69	69	77
	sound pressure dB(A)@1m	60	60	62
gas		R32	R32	R32

* Reach the data based on centrain condition

AUD-140UX4RSH1	AUD-160UX4RSH1	AUD-180TBD	AUD-200TBD	AUD-250TBD
				
				
14.5	16.0	Coming Soon	Coming Soon	Coming Soon
17.0	18.9	Coming Soon	Coming Soon	Coming Soon
6.0-18.0	6.0~18.5	Coming Soon	Coming Soon	Coming Soon
6.0-19.5	6.0~20.0	Coming Soon	Coming Soon	Coming Soon
4.09	4.78	Coming Soon	Coming Soon	Coming Soon
4.25	4.87	Coming Soon	Coming Soon	Coming Soon
3.55/3.52	3.35/3.33	Coming Soon	Coming Soon	Coming Soon
4.00/3.968	3.88/3.85	Coming Soon	Coming Soon	Coming Soon
4.74/4.56/4.89	4.58/4.38/4.69	Coming Soon	Coming Soon	Coming Soon
3.65/4.21/4.70	3.42/4.04/4.67	Coming Soon	Coming Soon	Coming Soon
1020/810/710	1120/920/780	Coming Soon	Coming Soon	Coming Soon
250	250	Coming Soon	Coming Soon	Coming Soon
56/53/49	58/55/51	Coming Soon	Coming Soon	Coming Soon
360*1520*820	360*1520*820	Coming Soon	Coming Soon	Coming Soon
440×1650×1055	440×1650×1055	Coming Soon	Coming Soon	Coming Soon
245*1152	245*1152	Coming Soon	Coming Soon	Coming Soon
2*400(Oval)	2*400(Oval)	Coming Soon	Coming Soon	Coming Soon
66.0	66.0	Coming Soon	Coming Soon	Coming Soon
1460*975*330	1460*975*330	Coming Soon	Coming Soon	Coming Soon
1590×1040×435	1590×1040×435	Coming Soon	Coming Soon	Coming Soon
98.0	98.0	Coming Soon	Coming Soon	Coming Soon
1 phase,220-240V,50Hz	1 phase,220-240V,50Hz	Coming Soon	Coming Soon	Coming Soon
18.3	21.2	Coming Soon	Coming Soon	Coming Soon
19.0	21.6	Coming Soon	Coming Soon	Coming Soon
31.0	31.0	Coming Soon	Coming Soon	Coming Soon
9.5(3/8) (flared)	9.5(3/8) (flared)	Coming Soon	Coming Soon	Coming Soon
15.9(5/8) (flared)	15.9(5/8) (flared)	Coming Soon	Coming Soon	Coming Soon
ID 25/OD 32	ID 25/OD 32	Coming Soon	Coming Soon	Coming Soon
75*	75*	Coming Soon	Coming Soon	Coming Soon
30	30	Coming Soon	Coming Soon	Coming Soon
30	30	Coming Soon	Coming Soon	Coming Soon
-10~50	-10~50	Coming Soon	Coming Soon	Coming Soon
-15~24	-15~24	Coming Soon	Coming Soon	Coming Soon
77	77	Coming Soon	Coming Soon	Coming Soon
62	62	Coming Soon	Coming Soon	Coming Soon
R32	R32	Coming Soon	Coming Soon	Coming Soon

* Reach the data based on ceatrain condition

Multi Head Split System



Ideal home air solution

Multi head split is ideal solution when an individual indoor unit is required in each room, the system allows one outdoor unit to be connected up to a wide variety of 2,3,4,5 indoor units, including wall-mounted, low static bulkhead duct.

Individual Temperature Control for Each Room

Individual Temperature Control for Each Room

Multi Head Split system main feature is controlling the temperature of all air conditioner units, even with different indoor units. Individual air conditioner control allows occupants in different rooms to select a temperature (within the same mode) that suits their needs, without affecting the temperature settings in other rooms.

Keep Your Exterior Clutter-Free

Multi Head Split Systems are conveniently designed to keep the exterior of your home clutter-free, with the ability to connect multiple (2-5) indoor air conditioning units to a single outdoor unit. With a Multi Head Split System, you can control 2-5 rooms with one outdoor unit, which not only keeps the exterior of your home clutter-free, but also keeps noise to the minimum.

Future Option for Your Family Grows

A large benefit of installing a Multi Head Split System is that additional air conditioner units can easily be added in the future, without having to install additional outdoor units. For instance, a five room Multi Split System may be installed, with only three rooms connected initially. Two more rooms may then be connected in the future, to the existing outdoor unit. Therefore, Multi Split Systems are future-proof, allowing you to plan for present circumstances, but also allow for changes to occur in the future.

Multi Indoor lineup for different rooms

Hisense multi head split indoor unit include wall-mounted and bulk head. These series have capacities from 2.1kw from 7.8kw class. It is easy to choose the right unit for every room in your home.



Wall-Mounted Type

Wall-mounted J Series features WI-FI, Easy Installation, from 2.1kw to 7.1kw class model.



Slim Ducted Type

Bulk head ducted features slim design and flexible installation, suitable for people who wish to use concealed units.



Multi Head Split Line



Indoor Unit

Indoor unit	2kw	2.5kw	3.5kw	5kw	7kw
Wall Mounted J series	 HAWJ7KR-I	 HAWJ9KR-I	 HAWJ12KR-I	 HAWJ18KR-I	 HAWJ24KRP-I
Low static bulkhead unit		 AMD-25UX4RAL4	 AMD-35UX4RBL4	 AMD-50UX4RCL4	 AMD-71UX4RCL4



Outdoor Unit

Max connected indoor units	5kw	7kw	8kw	10.5kw	12.5kw
2 IDU	 AMW2-52U4RJC			16kw	
3 IDU		 AMW3-71U4RJC			
4 IDU			 AMW4-80U4RJC	 AMW4-100U4RAA	
5 IDU					 AMW5-125U4RTA

Wall Mounted J Series



Cooling capacity	2.1Kw	2.5Kw	3.5Kw	5.3Kw	7.1Kw
	HAWJ7KR-I	HAWJ9KR-I	HAWJ12KR-I	HAWJ18KR-I	HAWJ24KRP-I
Heating capacity	2.5Kw	3.1Kw	3.8Kw	5.4Kw	7.2Kw
	HAWJ7KR-I	HAWJ9KR-I	HAWJ12KR-I	HAWJ18KR-I	HAWJ24KRP-I

Easy Installation

Equipped with supporting bar, it is very helpful for installer to free up one hand to complete other work during installation. Also, the under panel is detachable, benefit for drain pipe installation.



Voice Control

When the air conditioner is connected to Wi-Fi through the Hisense module, you can control the air conditioner by voice via Amazon or Google speakers, such as turning on the AC, setting mode.

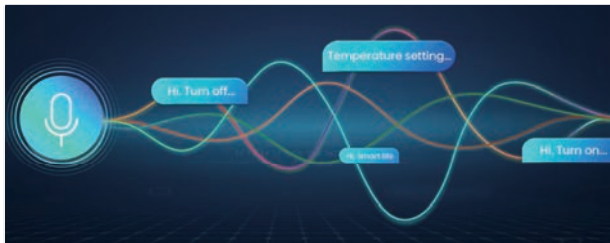

Wi-Fi Control

J series equip inbuilt WIFI module, through ConnectLife APP, you can control air conditioner any time and any where. When you are outside in hot summer day and want to enjoy cool temperature when arrived home, just pick up your phone and open air conditioner wirelessly.



Commercial Place Solutions

Dry contact output

1. There are conditions that AC need to work in equipment room, it requires that when AC has malfunction , the error signal needs to output because there is no person inside.
2. AC working , dry contact makes third party equipment working , AC stop, dry contact makes third party equipment stop.

Dry contact input

For different commercial applications, Hisense supply several dry contact input functions. After Input, several solution choices like standby /start operation/ return to last time operation status.

Healthy Filter

Equipped with silver ion healthy filter, air conditioner can effectively restrain dust, bacterial and vires. Bring you healthy life every day.

Eco-friendly R32 Refrigerant

Use of refrigerants with a lower impact on global warming is urgently required as climate change has become one of the most critical global issues. Hisense adopt R32 Refrigerant which has zone ozone layer depletion and less impart on global warming.

Evaporator Self Clean

Hisense patented self-clean technology of evaporator can keep your air conditioner clean and reduce bacteria, microorganisms, oil stains and so on, via a frosting and defrosting cycle, you can easily regain a clean air conditioner.

Quiet Mode

In the quiet mode, thanks to advanced quiet DC motor, unique cross flow fan and silent air duct design, AC noise can be at 19dB, user can have a quiet and comfortable environ.

Bulk Head



Cooling capacity	2.5Kw	3.6Kw	5.3Kw	7.2Kw
	AMD-25UX4RAL4	AMD-35UX4RBL4	AMD-50UX4RCL4	AMD-71UX4RCL4
Heating capacity	3.0Kw	3.8Kw	5.8Kw	7.8Kw
	AMD-25UX4RAL4	AMD-35UX4RBL4	AMD-50UX4RCL4	AMD-71UX4RCL4

Slim Design

The duct unit is only with 447mm in depth, enough for the ceiling width; 190mm in height, enough for the ceiling drop, both convenient for installation.

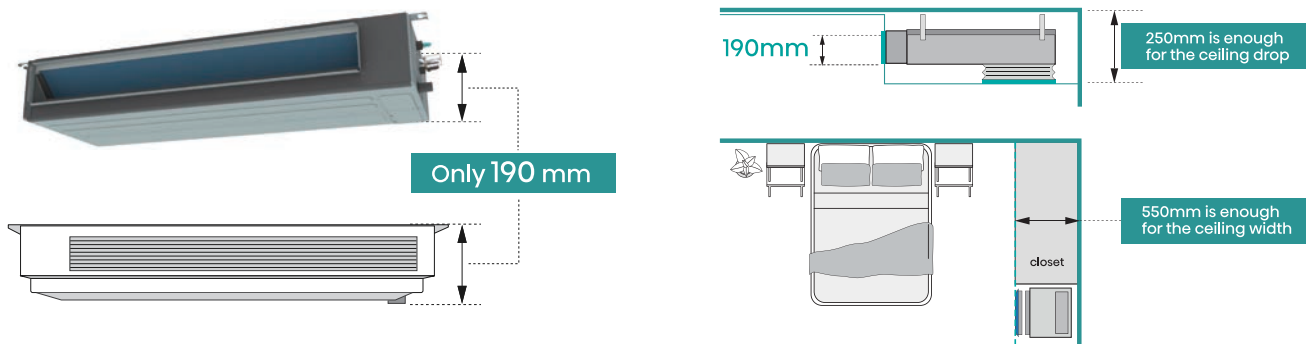

Easy Installation

Air suction direction can be altered from rear suction to bottom suction. We can install it for free use or for connecting to suction grilles.

* It is recommended to choose the rear suction because the noise from the rear suction is about 5 dB(A) lower than the bottom suction.

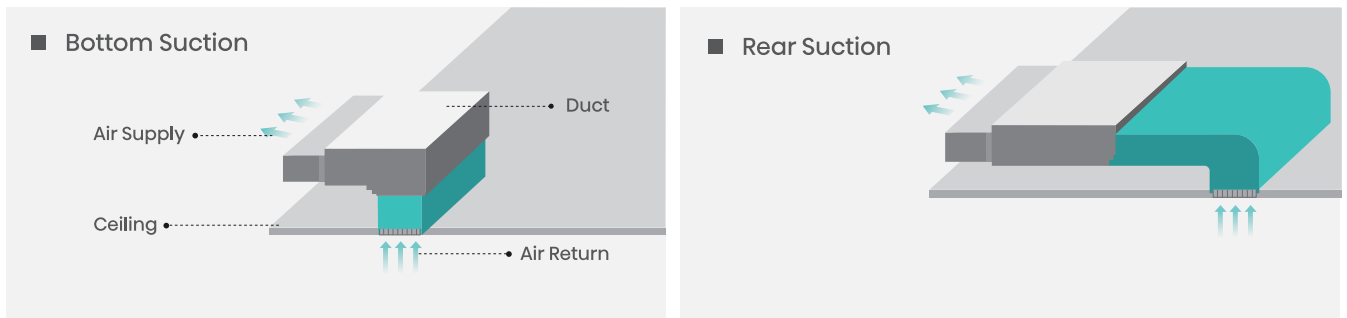

Built In Drain Pump

The drain pump is the standard part for the product, it gives the most flexibility in duct position design in apartment, because drain pump can lift and drain the water. 850mm height for the drain height.

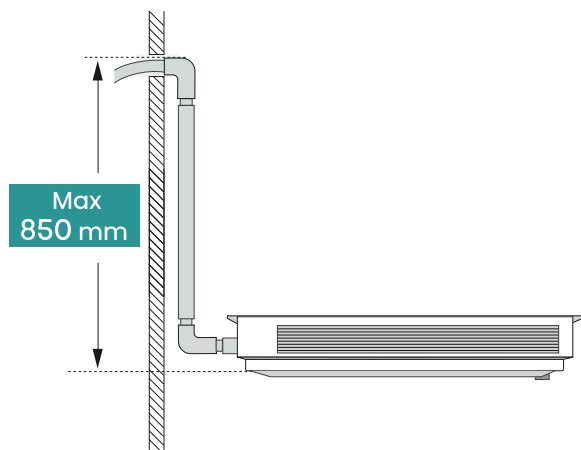

3D panel

The indoor unit can connect the 3D panel to reach temperature display, vertical swing & horizontal swing (3D swing).

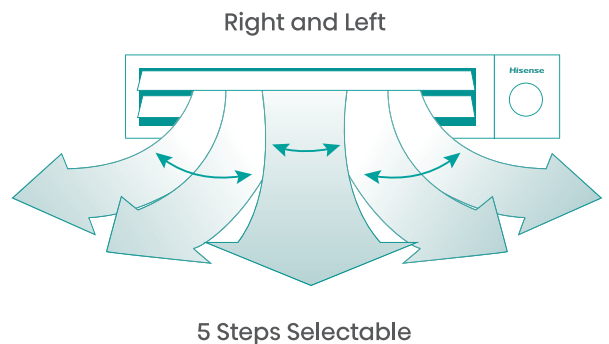

Outdoor Unit



ANTI-Corrosive Golden Fin

The unique anti-corrosive golden fin can withstand the salty air, rain and other corrosive elements. According to the salt spray test, the level of corrosion protection is significantly 3-4 times better than normal fin. It also has better hydrophilic, higher heat exchanging efficiency and is more attractive than normal fin.

1500 hour of Anti-Salt Spray

Anti-corrosion fin	1500h
Normal fin	500h

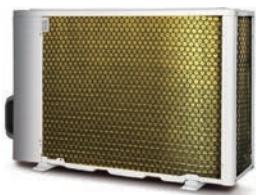

High heating efficiency
High Fashion
Anti-corrosion

PCB With Insect Prevention

The structure of PCB prevents insects from entering



Intelligent Defrost

When there is frost on the outdoor unit in winter, the sensor will check the temperature difference from the ambient and heat exchanger. When the differences get bigger, normally 8-degree differences and with 2 minutes, the product comes into defrost mode. The four-way valve will change to cooling mode, while the indoor fan will enter anti-cold flow mode, and the compressor will operate at high frequency for around 6-12 minutes. When the coil sensor goes up, it will quit the defrost mode and enter heating mode.



Refrigerant Leakage Detection

The outdoor unit will send an error code to the indoor unit when the refrigerant leakage ratio reaches a certain amount. The error code will display on the indoor screen for high wall units or on the wired controller for duct units. The control system will stop running to ensure safe operation of the air conditioner.



Easy Installation and Maintenance

RJ45 plug for DRED PCB

Australia require DRED connection, to suit the need, Hisense provide RJ45 port connection ,within 5 seconds we can finish the connection. Save installation time for the dealer.

■ Hisense Solution
5 Seconds

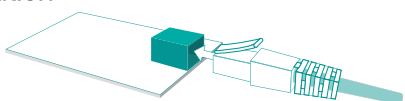

■ Normal Solution
60 Seconds

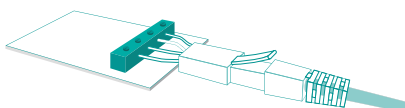

Hi-checker

The AC can connect to HI-CHECKER to monitor the product parameters, including discharge temperature, indoor coil temperature, outdoor coil temperature, etc.



Pump Down

Refrigerant easy recovering with only ONE-KEY.



Easy Adaptor

Multi head split system uses adaptor mostly in every case, Hisense adaptor is very easy to do the pipe size change , just rotate the adaptor on the stop valve, easy for installation.

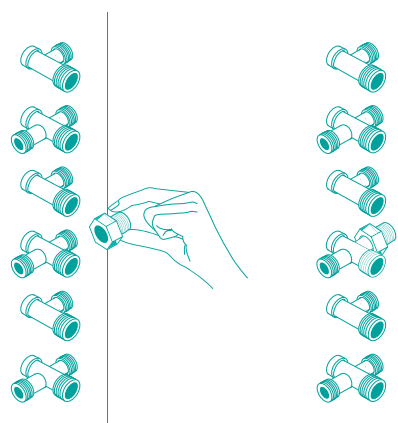

Step 1

Step 2

Indoor Unit Show Outdoor Error Code

All the outdoor unit detailed error code can be displayed on the indoor unit screen or wired controller, this function fasts the service speed for the dealer.

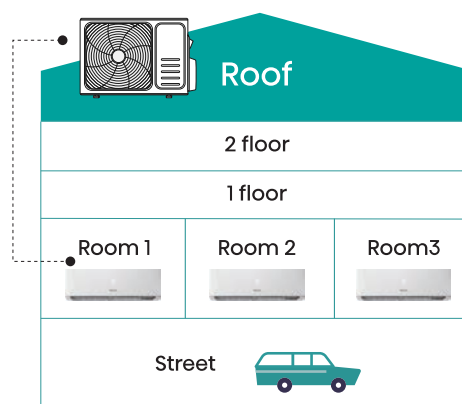

Based on right code, dealer can take right parts to the site and do the fast service.

Control Your Comfort



LCD Screen Wired Controller HACW01

Features

1. Wireless Signal Receiver

The controller has built in wireless signal receiver, user can use infrared wireless controller to send signal to the wired controller, more convenience because user don't need to go to wall controller position to operate.

2. Weekly Timer

Weekly timer is one ideal solution for user to set different operations for one week, the operation will repeat every week, just program once, convenient to use

3. Temperature Range Limit

Default temperature range is 16-30 °C and users can change the range when needed. For example, in cooling mode, temperature adjustment range could be changed to 23-30 °C; in heating mode, it could be changed to 16-23 °C.



Function	Wired Controller
	HACW01
LCD Screen	●
Back Light	●
Dimmer	●
Mute	●
On-off Setting	●
Auto Restart	●
Powerful	●
Quiet	●
Sleep	●
Up And Down Swing	●
Left And Right Swing	●
Health(hi Nano Healthy Function)	●
Modes : Cooling/Heating/Dry/Fan/Auto Fan	●
Mode Setting Cooling/Dry/Fan/Auto Fan	●
Clock	●
24 Hours Timer	●
Weekly Schedule	●
Temperature Range Limit	●
°C/°F	●
Room/Setting Temperature Display Switching	●
Error Code Display	●
Wireless Remote Receiver	●
Touch Button Lock	●
Filter Cleaning Remind	●

Control Your Comfort

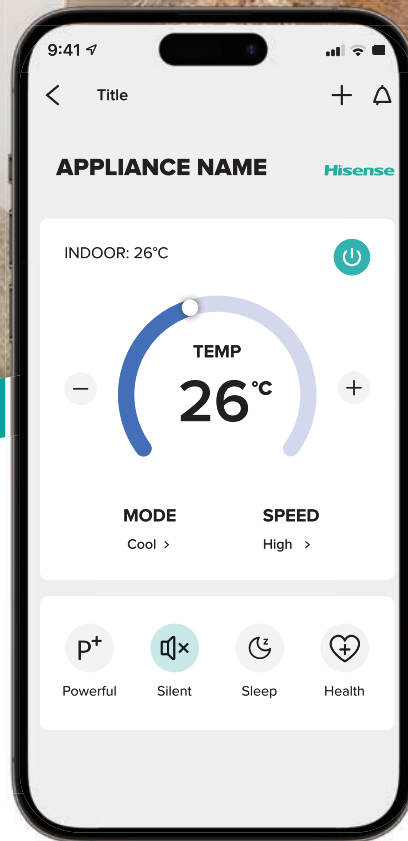

APP Control HAAW01

Features

1. Develop Operating Rules

Tailor your system to always meet your needs and unlock the full potential of your air conditioner. Program your system to automatically turn On/Off at specific times, change settings, and develop temperature rules to ensure superior comfort day after day.

2. Wi-Fi Control

Hisense air conditioning systems connected with Wi-Fi Control enabled. This means you can control it anytime and anywhere, enjoy hands-free control. For example, turn on or off, temperature setting, change mode.

3. Control Multiple Units

Customise the settings of each air conditioner in your home. Purchase multiple adaptors to manage all air conditioners independently on the same account, to ensure complete control over your system. The result is a tailored system to your needs.



Function	Market Model
	HAAW01
Start/stop operation	●
Modes:On/Off/Cooling/Heating/ Dry/Fan/Auto	●
Temperature Setting	●
Fan speed setting	●
Sleep mode	●
24 hours Timer	●
Weekly timer	●
Error Notification	●
Child Lock	
Operation Monitor	●
Room Temperature Display	●
Clock	●
Operation from outside	●
Multiple Users	●
energy consumption monitor	●



Remove Controller R2-01

Features

With an easy to read display and a variety of operating modes at the touch of a button. This controller features a 3 speeds and 24 hour timer, On/Off timer to set operating times on a daily basis. The I Feel button can keep you constant temperature all round

1.I Feel Function

The temperature sensor built in remote controller is activated. It can sense its surrounding temperature, and transmit the signal back the unit, the unit can adjust the temperature so as to provide maximum comfort.

2.Smart Mode

Enters SMART mode (fuzzy logic operation)directly only when the unit is on. Temperature and fan speed are automatically set based on the actual room temperature.





3.Quiet Mode

In quiet mode, the air conditioner will work with low noise performance by low compressor frequency and low fan speed. This mode is only available for inverter models.







Function	Market Model
	R2-01+R-A01Z(E)
Start/stop operation	●
Modes:On/Off/Cooling/Heating/Dry/ Fan/Auto	●
Temperature Setting	●
Fan speed setting	●
Sleep mode	●
High nano healthy function ON/OFF	●
24 hours Timer	●
Child Lock	●
Clock	●
Type	Wall Mounted/Duct(with receiver)





Function Overview

			Wall-Mounted				
							
Function List	No.	Model	HAWJ7KR-I	HAWJ9KR-I	HAWJ12KR-I	HAWJ18KR-I	HAWJ24KRP-I
Basic	1	Auto	●	●	●	●	●
	2	Cool	●	●	●	●	●
	3	Dry	●	●	●	●	●
	4	Fan	●	●	●	●	●
	5	Heat	●	●	●	●	●
Comfort	6	Anti-cold Air	●	●	●	●	●
	7	Auto Swing	●	●	●	●	●
	8	Faster Cooling	●	●	●	●	●
	9	Front Desk Control	●	●	●	●	●
	10	Louver Position Memory	●	●	●	●	●
	11	Sleep Mode	●	●	●	●	●
Efficiency	12	Full DC	●	●	●	●	●
	13	Motor Hi-smart					
	14	Timer-24h	●	●	●	●	●
Flexible	15	Duct Static Pressure Setting					
	16	Easy Cardboard					
	17	Easy Cleaning Filter	●	●	●	●	●
	18	Washable Filter	●	●	●	●	●
	19	No Wet Fin	●	●	●	●	●
	20	Self-cleaning	●	●	●	●	●
	21	Auto Restart	●	●	●	●	●
Stability	22	°C/°F exchange	●	●	●	●	●
	23	Central Control	●	●	●	●	●
	24	Child Lock					
	25	Display Switching					
	26	Error Alarm Port	●	●	●	●	●
	27	Error Code Display	●	●	●	●	●
	28	Filter Cleaning Remind					
	29	I Feel	●	●	●	●	●
	30	On-Off Fire Alarm	●	●	●	●	●
	31	Setpoint Range Set					
	32	Temperature Compensation	●	●	●	●	●
	33	Voice Command	●	●	●	●	●
	34	Weekly Schedule Timer					
	35	Wifi Ready	●	●	●	●	●
	36	Wireless Remote Receive	●	●	●	●	●
	37	High-lift Pump					
	Stability	38	Inner Pump Standard				
39		Water Level Switch					







Bulkhead

				
No.	AMD-25UX4RAL4	AMD-35UX4RBL4	AMD-50UX4RCL4	AMD-71UX4RCL4
1	●	●	●	●
2	●	●	●	●
3	●	●	●	●
4	●	●	●	●
5	●	●	●	●
6	●	●	●	●
7	●	●	●	●
8	●	●	●	●
9	●	●	●	●
10	●	●	●	●
11	●	●	●	●
12	●	●	●	●
13	●	●	●	●
14	●	●	●	●
15	●	●	●	●
16	●	●	●	●
17	●	●	●	●
18	●	●	●	●
19	●	●	●	●
20	●	●	●	●
21	●	●	●	●
22	●	●	●	●
23				
24	●	●	●	●
25	●	●	●	●
26	●	●	●	●
27	●	●	●	●
28	●	●	●	●
29	●	●	●	●
30	●	●	●	●
31	●	●	●	●
32	●	●	●	●
33				
34	●	●	●	●
35	●	●	●	●
36	●	●	●	●
37	●	●	●	●
38	●	●	●	●
39	●	●	●	●

Basic

-  **1. Auto**
Auto mode can be realized by remote controller or wired controller.
-  **2. Cool**
Cooling mode can be realized by the remote controller or the wired controller.
-  **3. Dry**
Dehumidifying mode can be realized by remote controller or wired controller.
-  **4. Fan**
Fan mode can be realized by remote controller or wired controller.
-  **5. Hot**
Heating mode can be realized by remote controller or wired controller.



Comfort

-  **6. Anti-Cold Air**
Prevent the cold air from blowing out during air conditioning heating. Once the heating function is turned on, enjoy the warmth immediately.
-  **7. Auto Swing**
Auto swing improve distribution of cooling, make you feel more comfortable.
-  **8. Faster Cooling**
Achieve fast cooling with high running frequency compressor, powerful fan, advanced air duct, heat-exchange system.
-  **9. Front Desk Control**
The 3D airflow panel can offer even airflow and wide airflow coverage to keep every corners of your room cool or warm.
-  **10. Louver Position Memory**
The panel louver restarts automatically at the original settings after power failure.
-  **11. Sleep Mode**
Press the SLEEP button, and the operation mode changes from adult SLEEP, elderly SLEEP, youth SLEEP and children SLEEP to closed SLEEP mode. Adjust the temperature curve according to different SLEEP modes. The temperature curve is customized within 8 hours according to the needs of different groups of people.

Efficiency

-  **12. All DC (Full DC)**
DC compressor + DC indoor & outdoor motors + EXV.
-  **13. Moter Hi-Smart**
Advanced inverter technology makes Hisense the inverter expert.
-  **14. Timer-24h**
Set a specific time during the day to have the AC automatically turn on or off.

Flexible

-  **15. Duct Static Pressure Setting**
It is possible to adjust the ESP setting via wired controller. And the precision of 1 Pa can give the most accurate ESP setting in class.
-  **16. Easy Cardboard**
Guide Cardboard makes it easy to install hook of the indoor unit.
-  **17. Easy Cleaning Filter**
The filter can be easily taken out, and easy to install.

Healthy

-  **18. No Wet Fin**
After turning off the AC, the indoor fan will continue running for 30 seconds, the evaporator and other parts of the indoor unit will be blown dry, prevent mildew growth.
-  **19. Self-Cleaning**
Self-clean technology of evaporator can keep your air conditioner clean and reduce bacteria, microorganisms, oil stains and so on, via a frosting and defrosting cycle.

Smart



20. Auto Restart

The unit restarts automatically at the original settings after power failure.



21. BACnet Gateway

The indoor unit can be connected to BMS system of the BAC net protocol by coordinating with B544E communication box.



22. C / F Exchange

Celsius and Fahrenheit can be converted to each other to meet different needs.



23. Central Control

Central Control can be realized with the help of central controller and communication box.



24. Child Lock

By setting the key lock, effectively avoid misoperation setting.



25. Display Switching

The wired controller can be set to display ambient temperature and set temperature.



26. Error Alarm Port

When failure occurs, PCB port will output 12VDC signal for alarm (it highlights remote alarm, 12VDC can be linked to alarm lights, also alarm bells can be installed. Competitors use alarm bells)



27. Error Code Display

We can identify the Error code through the panel display. When there is an error, the error code will flash. It is easier for us to troubleshoot.



28. Filter Cleaning Remind

If the AC runs for a long time, it will remind the user of cleaning the filter.



29. I Feel

The remote control is equipped with a temperature sensor to feel in with in the surrounding temperature.



30. On-Off_All On/All Off

A kind of special control mode to achieve the control of indoor unit startup & shutdown based on the input state of the fire protection port of the indoor unit and output the fault status of indoor unit through OUT INPUT port.



31. Setpoint Range Set

The setting of temperature range can be modified by the wired controller (manual modification can be realized).



32. Temperature Compensation

The ambient temperature monitored by the AC can be modified by the wired controller (Manual adjustment after the initial test).



33. Voice Command

When the air conditioner is connected to Wi-Fi through the Hisense module, you can control the air conditioner by voice via Amazon or Google speakers.



34. Weekly Schedule Timer

Timer can be set to start operation anytime on a daily or weekly basis.



35. Wifi Ready

The product is equipped with WIFI port. When WIFI function is needed, customers can purchase WIFI module.



36. Wireless Remote Receive

The wired controller can receive the control signal sent by the remote controller.

Stability



37. High-lift Pump

The maximum lift of Hisense high lift pump components can be as high as 1400mm.



38. Outer Pump Optional





External water pump to drain the condensate water.



39. Water Level Switch

The float switch can ensure the water always under the safety level, even if the pump failed or the drain is blocked.

Function Overview

Function Overview							
Function List	No.	Model	AMW2-52U4RJC	AMW3-71U4RJC	AMW4-80U4RJC	AMW4-100U4RAA	AMW5-125U4RTA
Efficiency	1	Motor Hi-Smart	●	●	●	●	●
	2	Twin Rotary compressor	●	●	●	●	●
Flexible	3	Charging Valve	●	●	●	●	●
	4	Hi-Smart	●	●	●	●	●
	5	Night Noise Control	●	●	●	●	●
	6	Refrigerant Pre charged	●	●	●	●	●
	7	Service Window - 7 Segment Display	●	●	●	●	●
Smart	8	Intelligent Defrost	●	●	●	●	●
	9	Service Window - Cooling only	●	●	●	●	●
	10	Service Window - Energy Management	●	●	●	●	●
	11	Service Window - Forced Defrost	●	●	●	●	●
	12	Service Window - Pump Down	●	●	●	●	●
Stability	13	3-minute Protection	●	●	●	●	●
	14	High Pressure Protection	●	●	●	●	●
	15	Leakage Detection	●	●	●	●	●
	16	Low Pressure Protection	●	●	●	●	●
	17	Low Voltage (176V)	●	●	●	●	●
	18	Low - Ambient Cooling (-15°C)	●	●	●	●	●
	19	PCB with Insect Prevention	●	●	●	●	●

Efficiency



1. Moter Hi-Smart

Advanced inverter technology makes Hisense the inverter expert. Better energy efficiency with external motor drive technology.



2. Twin Rotary Compressor

Twin rotary compressor has less noise and vibration.

Flexible



3. Charging Valve

The charging valve makes after-sales service easier.



4. Hi-Checker

The AC can connect to Hi-Checker to monitor the product parameters, including discharge temperature, indoor coil temperature, outdoor coil temperature, etc.



5. Night Noise Control

By setting DIP, can reduce the noise of the ODU operation, to ensure the outdoor silence when sleep at night.



6. Refrigerant Precharged

Up to 80% LCAC project can be installed without additional refrigerant charge.



7. Service Window-7 Segment Display

The fault code and AC running parameters will show on the 7-segment display.

Smart



8. Intelligent Defrost

The optimized defrosting logics ensures better heating capacity and cleaner defrosting.



9. Service Window-Cooling Only

By setting DIP, lock the unit, so it can not run in heating mode.



10. Service Window-Energy Management

By setting DIP, limit the maximum power input and decrease the outdoor noise.



11. Service Window-Forced Defrost

By setting DIP, the AC will run in defrosting mode.



12. Service Window-Pump Down

Recovering the refrigerant to the outdoor unit.

Stability



13. 3-minute Protection

When the AC stops running by accident, the compressor will restart after 3 minutes to balance the system.



14. High Pressure Protection

The outdoor unit is equipped with a high-voltage switch to ensure the product reliability.



15. Leakage Detection

The AC can detect and alert the refrigerant leakage if it occurs by monitoring the parameter abnormality.



16. Low Pressure Protection

The outdoor unit is equipped with a low-voltage switch to ensure the product reliability.



17. Low Voltage(176V)

The AC can still run stably even when the voltage is low to 176V.



18. Low-Ambient Cooling (-15)

The unit can operate low to -15°C in cooling mode.



19. PCB with Insect Prevention





The structure of PCB prevents insects from entering.

Scan the QR code for Combination Table



Specification





Wall Mounted Indoor Unit

Model Name		HAWJ7KR -I	HAWJ9KR -I	HAWJ12KR -I	HAWJ18KR -I	HAWJ24KRP-I
Product picture						
Cooling capacity	KW	2.1	2.5	3.5	5.3	7.1
Heating capacity	KW	2.5	3.1	3.8	5.4	7.2
Power Supply	V/Hz/f	220-240/50/1~	220-240/50/1~	220-240/50/1~	220-240/50/1~	220-240/50/1~
Air flow (H)	l/s	172	172	172	264	333
Noise Level (Sound Power)	dB(A)	59	59	59	62	65
Noise Level (Sound Pressure)	dB(A) (Max/Min)	39/25	39/25	41/25	44/32	48/35
Net Dimension - Indoor Unit (WxHxD)	mm	815×270×212	815×270×212	815×270×212	915×315×235	1085×315×235
Package Dimension - Indoor Unit (WxHxD)	mm	870×335×265	870×335×265	870×335×265	1000×390×315	1170×390×315
Net Weight - Indoor Unit	kg	7.7	8.5	8.5	12.5	13.5
Gross Weight - Indoor Unit	kg	9.5	11	11	14.5	16
Diameter(Liquid)	mm	Φ6.35(1/4')	Φ6.35(1/4')	Φ6.35(1/4')	Φ6.35(1/4")	Φ6.35(1/4")
Diameter(Gas)	mm	Φ9.52(3/8')	Φ9.52(3/8')	Φ9.52(3/8')	Φ12.7(1/2')	Φ12.7(1/2')
Drain	mm	Φ20	Φ20	Φ20	Φ20	Φ20

Bulk Head Indoor Unit

Model Name		AMD-25UX4RAL4	AMD-35UX4RBL4	AMD-50UX4RCL4	AMD-71UX4RCL4
Product picture					
Cooling capacity	KW	2.5	3.6	5.3	7.2
Heating capacity	KW	3.0	3.8	5.8	7.8
Power Supply	V/Hz/f	220-240/50/1~	220-240/50/1~	220-240/50/1~	220-240/50/1~
Air flow (H/M/L)	l/s	140/122/108	166/134/111	250/214/180	278/194/136
External static pressure	Pa	0~30	0~50	0~50	0~40
Noise Level (Sound Power)	dB(A)	49	50	57	58
Noise Level H/M/L (Sound Pressure)	dB(A)	35/33/31	36/33/30	41/37/33	39/35/32
Net Dimension (WxHxD)	mm	700×190×447	910×190×447	1180×190×447	1180×190×447
Package Dimension - Indoor Unit (WxHxD)	mm	870×565×285	1080×285×565	1350×285×565	1350×285×565
Net Weight	kg	16	18	22.5	24
Gross Weight	kg	20	21.5	26	29.5
Diameter(Liquid)	mm(inch)	Φ6.35(1/4')	Φ6.35(1/4')	Φ6.35(1/4")	Φ9.52(3/8')
Diameter(Gas)	mm(inch)	Φ9.52(3/8')	Φ9.52(3/8')	Φ12.7(1/2')	Φ15.88(5/8')
Drain	mm	Φ32	Φ32	Φ32	Φ32

Multi Head Split Outdoor Unit

Outdoor unit Model			AMW2-52U4RJC	AMW3-71U4RJC	AMW4-80U4RJC	AMW4-100U4RAA	AMW5-125U4RTA
Product Picture							
Max connected indoor unit			2	3	4	4	5
Performance							
Power supply		Outdoor	V/Hz/f	1/220-240/50	1/220-240/50	1/220-240/50	1/220-240/50
Max Current			A	16	17.3	17.5	32
Breaker size			A	20	32	32	50
Power cable			m2	3*2.5	3*2.5	3*2.5	3*6.0
communication cable			m2	4*1.5	4*1.5	4*1.5	4*1.5
Cooling	Capacity	Nominal	KW	5	7	8	10
		min~max	KW	2.1-6.5	2-10	2-10.5	3.0-11
	Input	Nominal	KW	1.20	1.92	2.23	3.05
	Current	Nominal	A	5.3	8.7	9.7	13.6
	EER/AEER	Nominal	W/W	4.17/4.07	3.65/3.57	3.59/3.52	3.28/3.23
Heating	Capacity	Nominal	KW	6.0	8.0	9.0	11.0
		min~max	KW	1.5-6.6	2-10	2-11	2.2-12
	Input	Nominal	KW	1.565	2.06	2.35	2.95
	Current	Nominal	A	6.8	9.3	10.2	12.9
	COP/ACOP	Nominal	W/W	3.83/3.77	3.88/3.81	3.83/3.76	3.73/3.67
Noise Level	Sound Power	dB(A)	63	63	64	68	75
Guaranteed Operating Range	Cooling	℃	-15-48	-15-48	-15-48	-15-48	-15-48
	Heating	℃	-15-24	-15-24	-15-24	-15-24	-15-24
Dimension & Weight							
Net Dimension (WxHxD)		mm	860×670×310	860×670×310	860×670×310	950×840×340	950×1050×340
Net Weight		kg	43	45	48	60	90
Package Dimension (WxHxD)		mm	990×730×450	990×730×450	990×730×450	1110×920×460	1110×1200×460
Gross Weight		kg	47	49	52	65	102
Technical Information							
Piping connections	Diameter(Liquid)	mm(inch)	6.35(1/4)×2	6.35(1/4)×3	6.35(1/4)×4	6.35(1/4)×4	6.35(1/4)×5
	Diameter(Gas)	mm(inch)	9.52(3/8)×2	9.52(3/8)×3	9.52(3/8)×4	9.52(3/8)×4	9.52(3/8)×5
	Max Length(Each)	m	20	25	25	25	25
	Max Length (Total)	m	30	50	60	60	80
	Max Height	m	15	15	15	15	15
Refrigerant	Type	-	R32	R32	R32	R32	R32
	GWP	-	675	675	675	675	675
	Pre-charged	g	1350	1460	1750	2000	3000
	Pre-charged pipe length(Total)	m	15	20	30	30	35
	additional refrigerant	g/m	12g/m over 15m	12g/m over 20m	12g/m over 30m	12g/m over 30m	12g/m over 35m

ADDITIONAL INFORMATION



Out door unit	model	AMW2-52U4RJC	AMW3-71U4RJC	AMW4-80U4RJC	AMW4-100U4RAA	AMW5-125U4RTA
Item	max connected indoor unit	Up to 2 indoor units	Up to 3 indoor units	Up to 4 indoor units	Up to 4 indoor units	Up to 5 indoor units
Piping to each indoor unit	m	20	25	25	25	25
Total length of piping between all units	m	30	50	60	60	80
Max height between indoor unit and outdoor unit	m	15	15	15	15	15
Max height between indoor unit	m	7.5	7.5	7.5	7.5	7.5
Max. allowed pipe length without additional refrigerant	m	15	20	30	30	35
Required amount of additional refrigerant	g/m	12g/m over 15m	12g/m over 20m	12g/m over 30m	12g/m over 30m	12g/m over 35m

Outdoor unit electrical data

Model	Phase	MCA	Power Input KW cooling	Power Input KW heating	Full Load Amps A
AMW2-52U4RJC	1/220-240/50	16	1.2	1.57	6.8
AMW3-71U4RJC	1/220-240/50	17.3	1.92	2.06	9.3
AMW4-80U4RJC	1/220-240/50	17.5	2.23	2.35	10.2
AMW4-100U4RAA	1/220-240/50	17.5	3.05	2.95	13.6
AMW5-125U4RTA	1/220-240/50	32	3.61	3.70	16.5

Accessories

3D Air-flow Panel

Model	Applicable Models	Outer Dimensions	Picture
PE-FBA-C	bulkhead 2.5/3.5kw	970*180*70	
PE-FCA-C	bulkhead 5/7.1kw	1240*180*70	

Wired Controller

HACW01	bulkhead/ high wall	(120*120*19)mm	
--------	------------------------	----------------	---

Wireless Controller

R2-01	bulkhead	(147*47*2.5)cm	
-------	----------	----------------	---

Wireless Signal Receiver

R-A01Z(E)	bulkhead	
-----------	----------	---

App

HAAW01	bulkhead/high wall	
--------	--------------------	---





BRAND NEW EXQUISITE PANEL SIMPLE AND ELEGANT

Simple design matches any
Decoration style

INTELLIGENT HIDDEN DISPLAY

Clear work status be known
at a glance



236MM ULTRA-THIN BODY SLIM AND SAVES MORE SPACE



236mm

MULTIPLE CONTROL METHODS
CHOOSE AS YOU LIKE



VARIOUS STYLES, SUITABLE FOR VARIOUS PLACES



ALL-ROUND HEALTH SUPPLY YOU HIGH QUALITY AIR

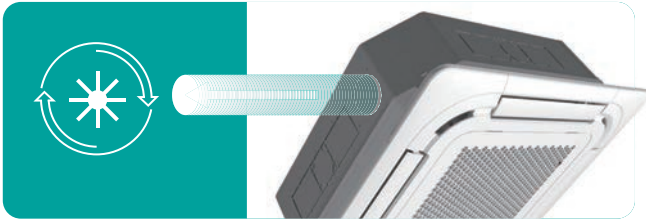

Fresh air introduce

Improve indoor air freshness

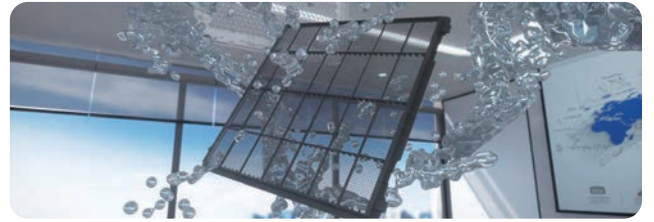

Easy-to-clean filter

Effectively filter harmful particles

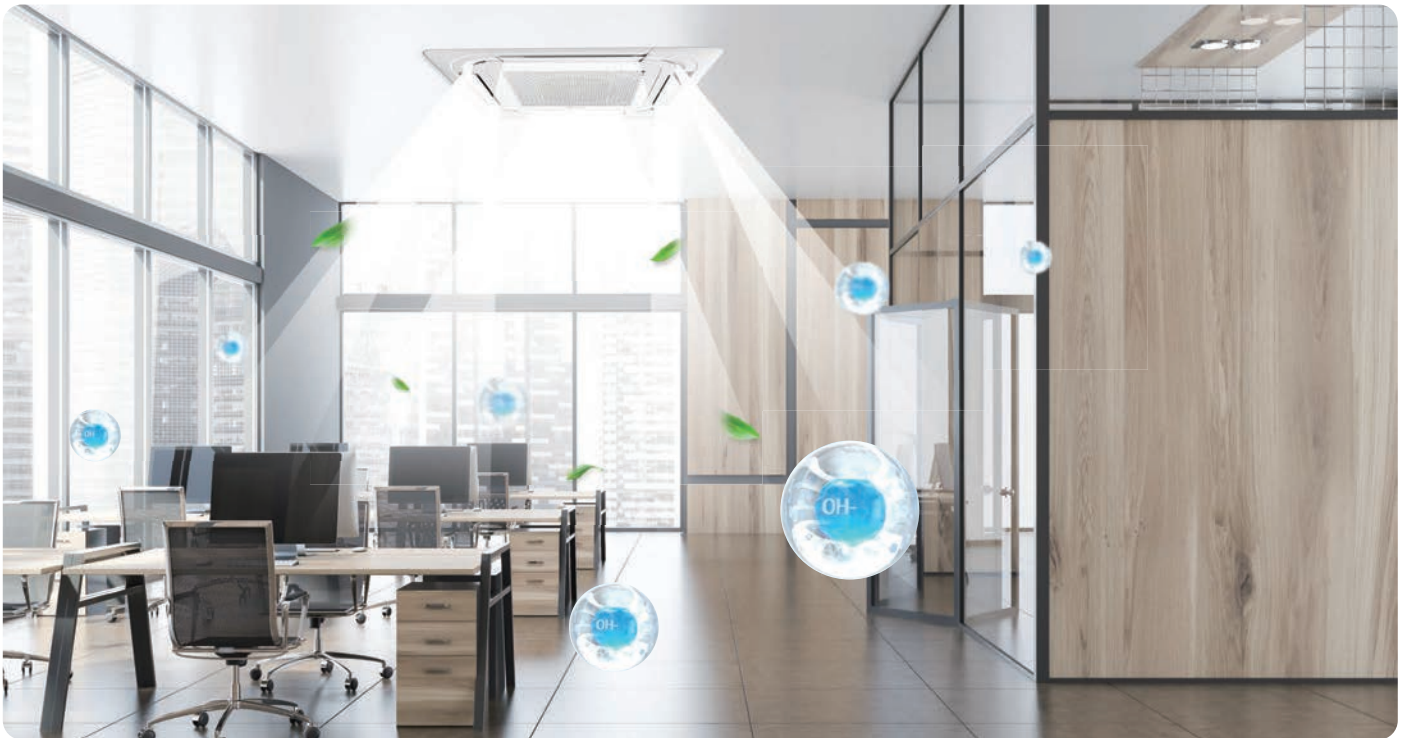

Hi-nano

Send sterile healthy ions to every corner to effectively remove viruses

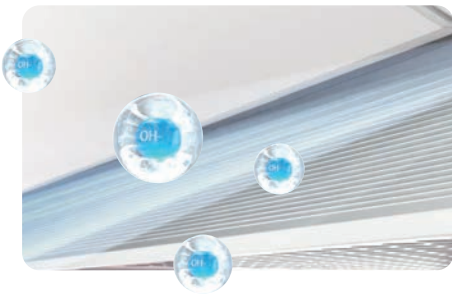

Send large amounts of sterilize ions to every corner



Effective sterilization and
Dust removal



Continuously deliver health

ALL-ROUND COMFORT ENJOY LIFE TO YOUR HEART'S COMTENT



360° round flow

Uniform temperature distribution

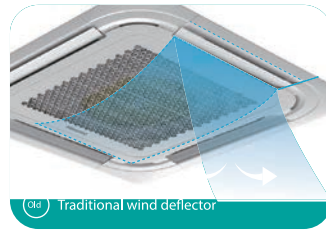

Old Traditional wind deflector

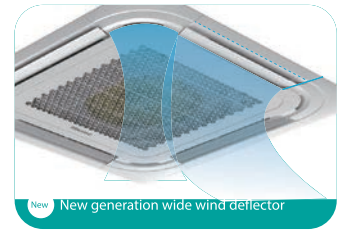

New New generation wide wind deflector

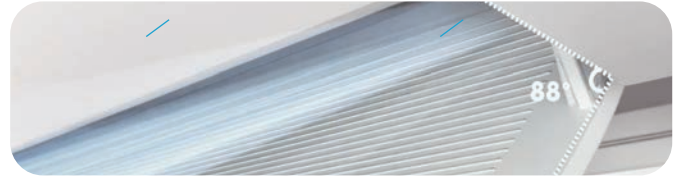

Big louver

With 88° free swinging angle



Ideal wind

Reaches every corner
enjoy natural cool breeze

Brand new silent air duct design

Silent air supply with optimized blades and professional duct simulation, create a peaceful environment.



ALL-ROUND INTELLIGENT TECHNOLOGY SMARTLY MEET CHANGING NEEDS



Independent control

Airflow direction can be individually adjusted for each air discharge outlet to deliver optimal air distribution.

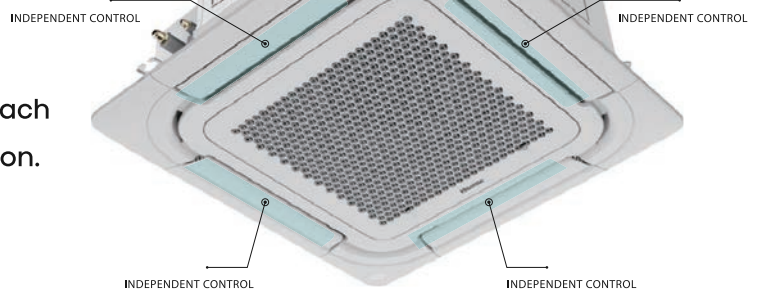

Wifi & APP control

Remotely controlling the air conditioner through the mobile phone APP before returning home makes life more convenient.

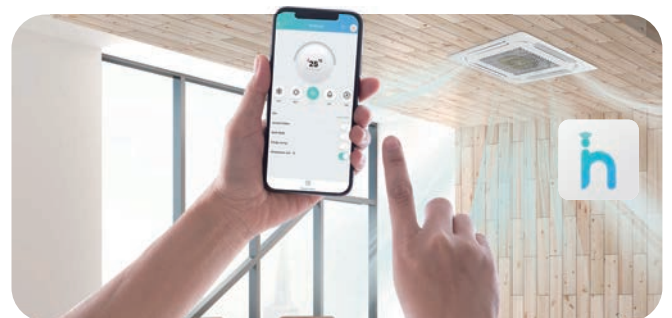

ALL-ROUND QUALITY ASSURANCE

EFFICIENT, SAFE AND RELIABLE



R32 refrigerant

Environmentally friendly and efficient

Flexible Installation

Anti-overflow design and high-lift water pump, pipeline installation is more flexible

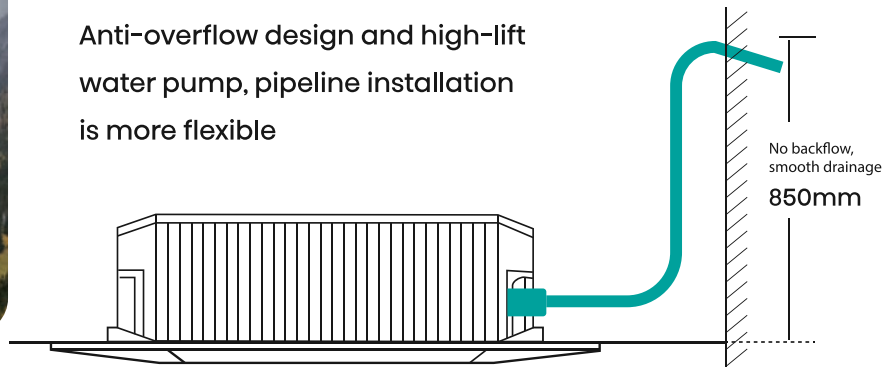

Backward centrifugal fan

With excellent air supply, high efficiency, low noise and loss, higher reliability.



Five-fold evaporator



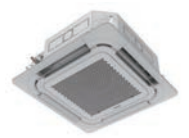
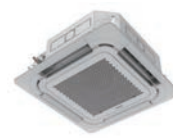
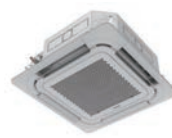
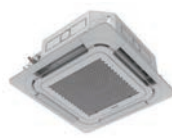

Larger heat exchange area, higher efficient, more power-saving than traditional four-fold evaporator.

FUNCTION OVERVIEW









Function List	No.	Model	AUC-71UR4RKCI	AUC-100UR4RKCI	AUC-125UR4RKCI	AUC-140UR4RKCI
Basic	1	Auto	●	●	●	●
	2	Cool	●	●	●	●
	3	Dry	●	●	●	●
	4	Fan	●	●	●	●
	5	Heat	●	●	●	●
Comfort	6	Anti-cold Air	●	●	●	●
	7	Auto Swing	●	●	●	●
	8	Faster Cooling	●	●	●	●
	9	Louver Position Memory	●	●	●	●
	10	Multi Zoning				
	11	Round Flow	●	●	●	●
Efficiency	12	Sleep Mode	●	●	●	●
	13	Full DC	●	●	●	●
	14	Motor Hi-smart	●	●	●	●
Flexible	15	Timer-24h	●	●	●	●
	16	Duct Static Pressure Setting				
	17	Easy Cardboard	●	●	●	●
	18	Easy Cleaning Filter	●	●	●	●
Healthy	19	High Ceiling Application(3m/4m)	●	●	●	●
	20	Washable Filter	●	●	●	●
	21	Fresh Air Intake	●	●	●	●
	22	Healthy Drain Pan	●	●	●	●
Smart	23	No Wet Fin	●	●	●	●
	24	Self-cleaning	●	●	●	●
	25	8°C Special Heating				
	26	Auto Restart	●	●	●	●
	27	BACnet Gateway	●	●	●	●
	28	°C/°F exchange	●	●	●	●
	29	Central Control	●	●	●	●
	30	Child Lock	●	●	●	●
	31	Display Switching	●	●	●	●
	32	Energy Consumption Monitor				
Stability	33	Error Alarm Port	●	●	●	●
	34	Error Code Display	●	●	●	●
	35	Filter Cleaning Remind	●	●	●	●
	36	I Feel	●	●	●	●
	37	Individual Airflow Control	●	●	●	●
	38	On-Off Fire Alarm	●	●	●	●
	39	Setpoint Range Set	●	●	●	●
	40	Temperature Compensation	●	●	●	●
	41	Weekly Schedule Timer	●	●	●	●
	42	Wifi Ready	●	●	●	●
	43	Wireless Remote Receive	●	●	●	●
Stability	44	Inner Pump	●	●	●	●
	45	Modbus Gateway	●	●	●	●
	46	Water Level Switch	●	●	●	●

Basic

-  **1. Auto**
Auto mode can be realized by remote controller or wired controller.
-  **2. Cool**
Cooling mode can be realized by the remote controller or the wired controller.
-  **3. Dry**
Dehumidifying mode can be realized by remote controller or wired controller.
-  **4. Fan**
Fan mode can be realized by remote controller or wired controller.
-  **5. Hot**
Heating mode can be realized by remote controller or wired controller.





Comfort

-  **6. Anti-Cold Air**
Prevent the cold air from blowing out during air conditioning heating. Once the heating function is turned on, enjoy the warmth immediately.
-  **7. Auto Swing**
Auto swing improve distribution of cooling, make you feel more comfortable.
-  **8. Faster Cooling**
Achieve fast cooling with high running frequency compressor, powerful fan, advanced air duct, heat-exchange system.
-  **9. Louver Position Memory**
The panel louver restarts automatically at the original settings after power failure.
-  **10. Multi Zoning**
Allows up to XX individual climate zones with one indoor unit.
-  **11. Round Flow**
"Round air supply optimizes room airflow, ensure the comfortable airflow goes to every corner and the temperature perfectly balance the integral space."
-  **12. Sleep Mode**
Press the SLEEP button, and the operation mode changes from adult SLEEP, elderly SLEEP, youth SLEEP and children SLEEP to closed SLEEP mode. Adjust the temperature curve according to different SLEEP modes. The temperature curve is customized within 8 hours according to the needs of different groups of people.





Efficiency

-  **13. All DC (Full DC)**
DC compressor + DC indoor & outdoor motors + EXV.
-  **14. Moter Hi-Smart**
Advanced inverter technology makes Hisense the inverter expert.
-  **15. Timer-24h**
Set a specific time during the day to have the AC automatically turn on or off.

Flexible

-  **16. Duct Static Pressure Setting**
It is possible to adjust the ESP setting via wired controller. And the precision of 1 Pa can give the most accurate ESP setting in class.
-  **17. Easy Cardboard**
Guide Cardboard makes it easy to install hook of the indoor unit.
-  **18. Easy Cleaning Filter**
The filter can be easily taken out, and easy to install.
-  **19. High Ceiling Application (3m/4m)**
The wired controller can be used to adjust the airflow according to the installation height and ensure that cool air blows down to people's activity area.
-  **20. Washable Filter**
The filter can be cleaned for repeated use.

Healthy

-  **21. Fresh Air Intake**
"Fresh air intake interface is reserved on the side panel, which can be connected to air duct to introduce fresh air into the room with fresh air intake function, the indoor air is fresh and healthy."
-  **22. Healthy Drain Pan**
Antibacterial Module can effectively purify condensed water and provide more healthy air supply.
-  **23. No Wet Fin**
After turning off the AC, the indoor fan will continue running for 30 seconds, the evaporator and other parts of the indoor unit will be blown dry, prevent mildew growth.
-  **24. Self-Cleaning**
Self-clean technology of evaporator can keep your air conditioner clean and reduce bacteria, microorganisms, oil stains and so on, via a frosting and defrosting cycle.

Smart



25. 8°C Special Heating

During absence, the indoor temperature can be maintained at a certain level.



26. Auto Restart

The unit restarts automatically at the original settings after power failure.



27. BACnet Gateway

The indoor unit can be connected to BMS system of the BAC net protocol by coordinating with B544E communication box.



28. °C/°F Exchange

Celsius and Fahrenheit can be converted to each other to meet different needs.



29. Central Control

Central Control can be realized with the help of central controller and communication box.



30. Child Lock

By setting the key lock, effectively avoid misoperation setting.



31. Display Switching

The wired controller can be set to display ambient temperature and set temperature.



32. Energy Consumption Monitor

Power consumption can display on the CONNECT LIFE APP. (The user can check the power consumption on the APP)



33. Error Alarm Port

When failure occurs, PCB port will output 12VDC signal for alarm (it highlights remote alarm, 12VDC can be linked to alarm lights, also alarm bells can be installed. Competitors use alarm bells)



34. Error Code Display

We can identify the Error code through the panel display. When there is an error, the error code will flash. It is easier for us to troubleshoot.



35. Filter Cleaning Remind

If the AC runs for a long time, it will remind the user of cleaning the filter.



36. I Feel

The remote control is equipped with a temperature sensor to feel 1m with in the surrounding temperature.



37. Individual Airflow Control

Each deflector can be controlled separately by a wired controller.



38. On-Off Fire Alarm

With the fire control, the A/C will be turned OFF automatically when the smoke detector alarm is activated.



39. Setpoint Range Set

The setting of temperature range can be modified by the wired controller (manual modification can be realized).



40. Temperature Compensation

The ambient temperature monitored by the AC can be modified by the wired controller (Manual adjustment after the initial test).



41. Weekly Schedule Timer

Timer can be set to start operation anytime on a daily or weekly basis.



42. Wifi Ready

The product is equipped with WIFI port. When WIFI function is needed, customers can purchase WIFI module.



43. Wireless Remote Receive

The wired controller can receive the control signal sent by the remote controller.

Stability



44. Inner Pump Standard

Inner water pump to drain the condensate water.



45. Modbus Gateway





The indoor unit can be connected to BMS system of the Modbus protocol by coordinating with B544E communication box.



46. Water Level Switch

The float switch can ensure the water always under the safety level, even if the pump failed or the drain is blocked.

FUNCTION OVERVIEW

						
Function List	No.	Model	AUW-7U4RBI	AUW-100U4RK1	AUW-125U4RN1	AUW-140U4RN1
Efficiency	1	Motor Hi-Smart	●	●	●	●
	2	Twin Rotary compressor	●	●	●	●
Flexible	3	Charging Valve	●	●	●	●
	4	Hi-Checker			●	●
	5	Night Noise Control	●	●	●	●
	6	Refrigerant Pre charged	●	●	●	●
	7	Service Window-7 Segment Display			●	●
	8	Stop Valve Inside			●	●
Smart	9	Intelligent Defrost	●	●	●	●
	10	Service Window-Cooling only			●	●
	11	Service Window-Energy Management			●	●
	12	Service Window-Forced Defrost			●	●
	13	Service Window-Pump Down			●	●
Stability	14	3-minute Protection	●	●	●	●
	15	Compressor Heating Belt			●	●
	16	High Pressure Protection	●	●	●	●
	17	Leakage Detection	●	●	●	●
	18	Long Pipe	●	●	●	●
	19	Low Pressure Protection	●	●	●	●
	20	Low Voltage (176V)	●	●	●	●
	21	PCB with Insect Prevention	●	●	●	●
	22	Refrigerant cooled PCB			●	●

Efficiency



1. Motor Hi-Smart

Advanced inverter technology makes Hisense the inverter expert. Better energy efficiency with external motor drive technology.



2. Twin Rotary Compressor

Twin rotary compressor has less noise and vibration.

Flexible



3. Charging Valve

The charging valve makes after-sales service easier.



4. Hi-Checker

The AC can connect to Hi-Checker to monitor the product parameters, including discharge temperature, indoor coil temperature, outdoor coil temperature, etc.



5. Night Noise Control

By setting DIP, can reduce the noise of the ODU operation, to ensure the outdoor silence when sleep at night.



6. Refrigerant Precharged

Up to 80% LCAC project can be installed without additional refrigerant charge.



7. Service Window-7 Segment Display

The fault code and AC running parameters will show on the 7-segment display.



8. Stop Valve Inside

The new built-in design, it can be realize 4 way pipe connection.

Smart



9. Intelligent Defrost

The optimized defrosting logics ensures better heating capacity and cleaner defrosting.



10. Service Window-Cooling Only

By setting DIP, lock the unit, so it can not run in heating mode.



11. Service Window-Energy Management

By setting DIP, limit the maximum power input and decrease the outdoor noise.



12. Service Window-Forced Defrost

By setting DIP, the AC will run in defrosting mode.

Smart



13. Service Window-Pump Down

Recovering the refrigerant to the outdoor unit.

Stability



14. 3-minute Protection

When the AC stops running by accident, the compressor will restart after 3 minutes to balance the system.



15. Compressor Heating Belt

AC with compressor electric belt can still run stably in frigid regions.



16. High Pressure Protection

The outdoor unit is equipped with a high-voltage switch to ensure the product reliability.



17. Leakage Detection

The AC can detect and alert the refrigerant leakage if it occurs by monitoring the parameter abnormality.



18. Long Pipe

the ACs With high installation flexibility.



19. Low Pressure Protection

The outdoor unit is equipped with a low-voltage switch to ensure the product reliability.



20. Low Voltage(176V)

The AC can still run stably even when the voltage is low to 176V.



21. PCB with Insect Prevention









The structure of PCB prevents insects from entering.

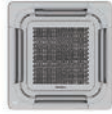

22. Refrigerant cooled PCB

Hisense uses refrigerant cooling technology to cool the electrical control box. It overcomes the poor heat dissipation and high ambient temperature issues to maintain efficient operation even at harsh environment.

Specification

Indoor Unit Model				AUC-71UR4RJC1	AUC-100UR4RKC1	AUC-125UR4RKC1	AUC-140UR4RKC1	
Outdoor Unit Model				AUW-71U4RB1	AUW-100U4RK1	AUW-125U4RN1	AUW-140U4RN1	
IndoorPicture								
OutdoorPicture								
Electricparameter	Powersupply	Outdoor	V-ph-Hz	220-240/1/50&60	220-240/1/50&60	220-240/1/50&60	220-240/1/50&60	
	Inputconsumption	Max.	W	4100	4000	6400	7200	
	Inputcurrent	Max.	A	18.1	22	28.2	30	
Cooling	Capacity	Nominal	KW	7.3	10	12.5	13.3	
		Min - Max	KW	2.4-8.0	2.5-11.5	2.7-13.5	2.7-14.6	
	Input	Nominal	KW	2.15	2.94	3.91	4.43	
	Current	Nominal	A	9.3	12.8	17	19.3	
	EER	Nominal	KW/KW	3.4	3.4	3.2	3	
Heating	Capacity	Nominal	KW	8.3	11.2	14	15	
		Min - Max	KW	2.1-9.0	2.5-12.5	2.7-16.0	2.7-17.0	
	Input	Nominal	W	2.44	3.2	4.18	4.69	
	Current	Nominal	A	10.6	13.9	18.2	20.4	
COP	Nominal	KW/KW	3.4	3.5	3.35	3.2		
Indoorunit	Dimension	H×W×D	mm	236×840×840	272×840×840	272×840×840	272×840×840	
	Packing	H×W×D	mm	320×950×950	360×950×950	360×950×950	360×950×950	
	Weight	Net/Gross	kg	23/28	26/32	26.0/32.0	26.0/32.0	
	AirVolume	Hi/Med/Lo	l/s	333/277/233	555/468/430	555/468/430	555/468/430	
	SoundLevel(SPL)	Hi/Med/Lo	dB(A)	43/40/37	52/49/46	52/49/46	52/49/46	
	SoundLevel(PWL)	Hi	dB(A)	54	64	64	64	
	Controller	Type	Wireless		RCH-RVD01	RCH-RVD01	RCH-RVD01	RCH-RVD01
		Type	Wired		HACW02	HACW02	HACW02	HACW02
Drainagewaterpipediameter		mm		ODΦ32	ODΦ32	ODΦ32	ODΦ32	
Panel	Dimension	W×H×D	mm	950×50×950	950×50×950	950×50×950	950×50×950	
	Packing	W×H×D	mm	1020×105×1000	1020×105×1000	1020×105×1000	1020×105×1000	
	Weight	Net/Gross	kg	6.5/9	6.5/9	6.5/9	6.5/9	
Compressor	Type		—	ROTARY	ROTARY	ROTARY	ROTARY	
Outdoorunit	Dimension	H×W×D	mm	650×860×310	750×900×340	1170×900×320	1170×900×320	
	Packing	H×W×D	mm	700×1170×390	820×1060×450	1300×970×430	1300×970×430	
	Weight	Net/Gross	kg	46/50	52.0/56.0	83.0/91.0	83.0/91.0	
	SoundLevel(SPL)	Hi	dB(A)	57	57	58	60	
	SoundLevel(PWL)	Hi	dB(A)	69	69	70	72	
	Refrigerant	Type	—		R32	R32	R32	R32
Amount		kg		1.7	2.2	3.7	3.7	
piping	Liquid/Gas		mm(inch)	Φ9.52/Φ15.88(3/8"/5/8')	Φ9.52/Φ15.88(3/8"/5/8')	Φ9.52/Φ15.88(3/8"/5/8')	Φ9.52/Φ15.88(3/8"/5/8')	
	connectionmethod			flared	flared	flared	flared	
	Pipelength	Max.	m		30	50	50	50
		Heightdifference	Max.(ODlower)	m		20	30	30
		Max.(ODhigher)	m		20	30	30	
Prechargelength		m		20	20	20	20	
OperatingRange (Outdoor)	Cooling		°C		-10~46	-10~46	-10~46	
	Heating		°C		-15~24	-15~24	-15~24	

ACCESSORIES

Wired Controller

Model	Applicable Types	Dimension(W*H*D)	
HACW02	high static ducted& cassette	120mm*120mm*19mm	

Zone Wired Controller

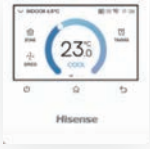
Model	Applicable Types	Dimension(W*H*D)	
HACZ01	high static ducted	120mm*120mm*17mm	

Zone control interface

Model	Description	Applicable Types	Dimension(W*H*D)	
HAAZ01	8 zone,24V	high static ducted	335mm*231mm*81mm	

Zone APP

Model	Applicable Types	
HACZ01 built in wifi	high static ducted	

APP

Model	Applicable Types	
HACZ01	high static ducted cassette	

Hi-NANO generator

Model	Connection	Applicable Types	
Hinano-01A	from indoor unit PCB terminal	high static ducted	

HI-NANO cassette panel

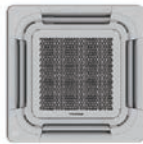
Model	Applicable Types	
PE-QFA/CDH	cassette	

Wireless controller

No.	Model	Applicable Types	
1	R2-01	high static ducted	
2	RCH-RVD01	cassette	

Adaptor for Central Controller

Model	Applicable Types	Dimension(W*H*D)	
B544(E)	high static ducted cassette	134mm*180mm*21mm	

Central Controller

Model	Applicable Types	Dimension(W*H*D)	
YJE-C01T(E)	high static ducted cassette	120mm*120mm*19mm	



Hisense Australia Pty. Ltd
Level 1, 37 Dalmore Drive, Scoresby, VIC 3179

Customer Support

- ☎ 03 9765 8859
- ✉ hvacorders@hisense.com
- 🌐 airconditioning.hisense.com.au

Service / Spare Parts / Tech Support

- ☎ 03 9765 8836(Direct Line)
- ✉ hvacservice@hisense.com

Note: Product design and specification subject to change without prior notice.
© 2024 Hisense Corporation. All rights reserved. Hisense the Hisense logo and the Just Makes Sense logo are trademarks or registered trademarks of Hisense Group in China and/or other countries. All rights reserved. All other company names, brand names, trademarks and logos are the property of their respective owners. All rights reserved.

